

Compact cylinders - Series 31

Product code: 31M3A063A050

Datasheet creation date: 07/03/2025 20:43

Check the most updated document online [click here](#)



TECHNICAL DATA

Series	31
Version	M=male rod thread
Operation	3=double-acting through rod
Diameter (mm)	63
Stroke type	standard
Stroke (mm)	50
Rod seals material	-
Materials	A = rolled stainless steel AISI 303 rod tube profile aluminium
Construction	A = standard

Compact cylinders - Series 31

Product code: 31M3A063A050

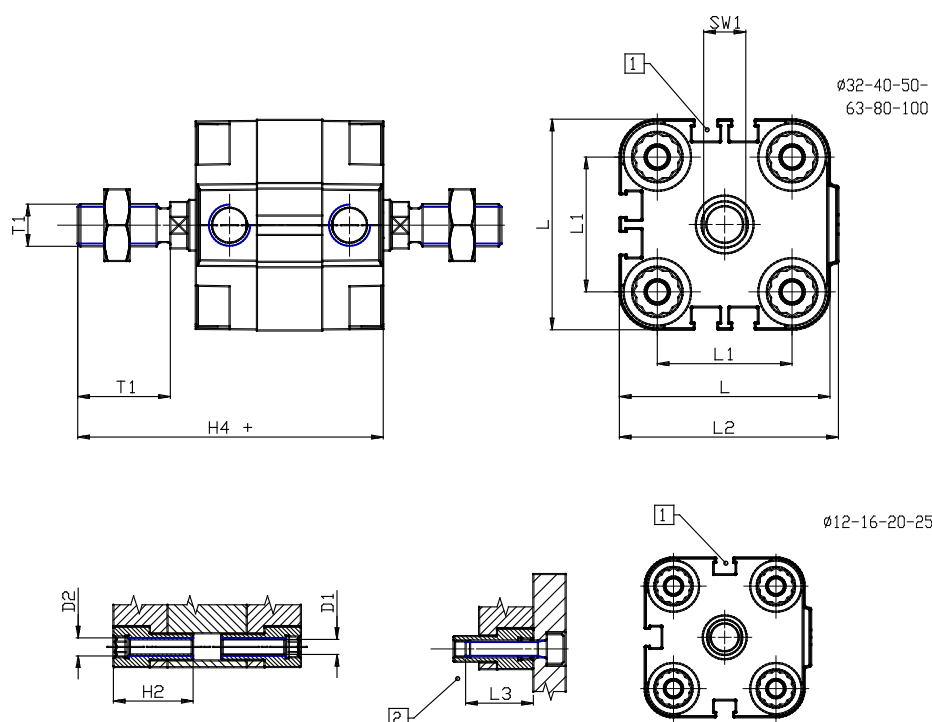

DIMENSIONS

Ø D (mm)	16
Ø D1 (mm)	8.5
D2	M10
D3	M8
Ø D4 (mm)	6
D5	M6
Ø D8 (mm)	8
D9 (mm)	10
D10 (mm)	22
E1	G1\8
F (mm)	8.0
F1 (mm)	42.0
H (mm)	50.0
H1 (mm)	57.5
H2 (mm)	24.5
K1	M12x1,25
L (mm)	87
L1 (mm)	62
L2 (mm)	91.0
L3 (mm)	25
L4 (mm)	35.4
T (mm)	12
T1 (mm)	24

T2 (mm)	4
SW1 (mm)	13