

Compact cylinders - Series 31

Product code: 31M3A100A090

Datasheet creation date: 07/03/2025 20:10

Check the most updated document online [click here](#)



TECHNICAL DATA

Series	31
Version	M=male rod thread
Operation	3=double-acting through rod
Diameter (mm)	100
Stroke type	variable
Stroke (mm)	90
Rod seals material	-
Materials	A = rolled stainless steel AISI 303 rod tube profile aluminium
Construction	A = standard

Compact cylinders - Series 31

Product code: 31M3A100A090

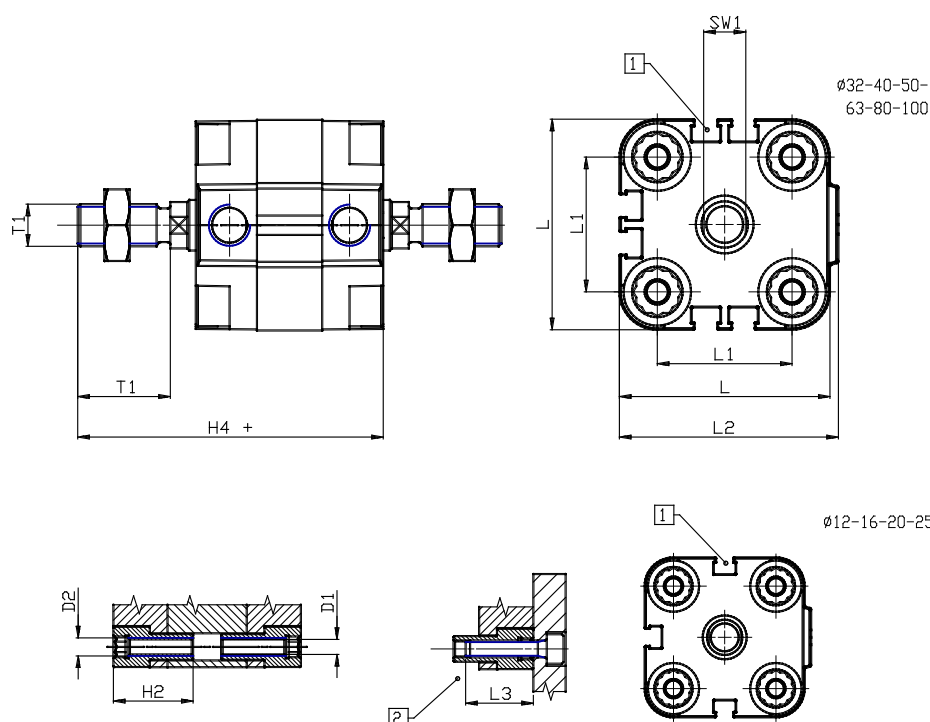

DIMENSIONS

Ø D (mm)	25
Ø D1 (mm)	8.5
D2	M10
D3	M12
Ø D4 (mm)	10
D5	M10
Ø D8 (mm)	8
D9 (mm)	12
D10 (mm)	30
E1	G1/4
F (mm)	10.0
F1 (mm)	56.0
H (mm)	66.5
H1 (mm)	76.5
H2 (mm)	31.5
K1	M20x1,5
L (mm)	128
L1 (mm)	103
L2 (mm)	133.0
L3 (mm)	25
L4 (mm)	56.6
T (mm)	20
T1 (mm)	40

T2 (mm)	4
SW1 (mm)	22