

Compact cylinders - Series 31

Product code: 31R3A016A025

Datasheet creation date: 07/03/2025 19:25

Check the most updated document online [click here](#)



TECHNICAL DATA

Series	31
Version	R=non-rotating with flange only double acting
Operation	3=double-acting through rod
Diameter (mm)	16
Stroke type	standard
Stroke (mm)	25
Rod seals material	-
Materials	A = rolled stainless steel AISI 303 rod tube profile aluminium
Construction	A = standard

Compact cylinders - Series 31

Product code: 31R3A016A025

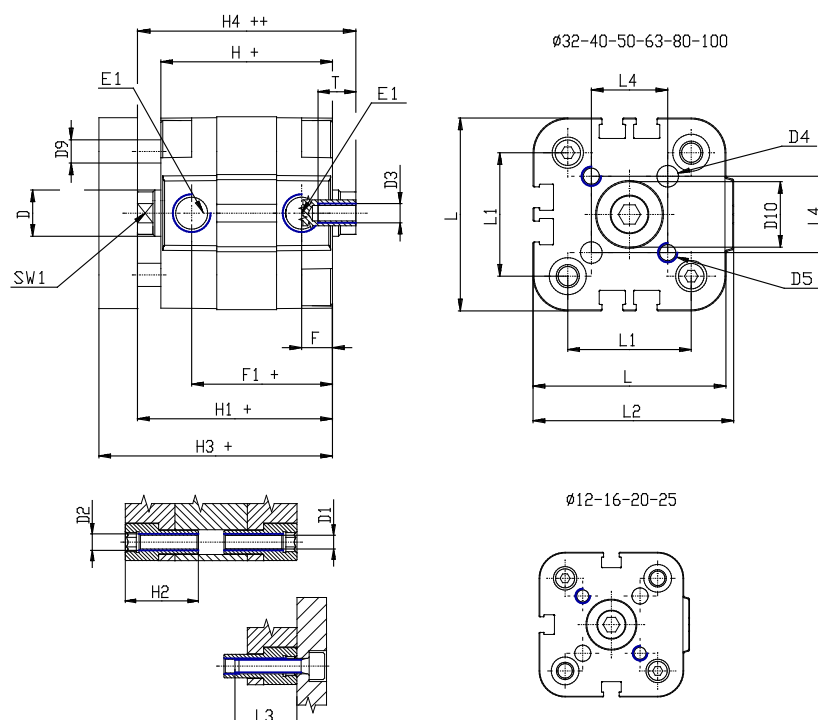

DIMENSIONS

Ø D (mm)	8
Ø D1 (mm)	3.5
D2	M4
D3	M4
Ø D4 (mm)	3
D5	M3
Ø D8 (mm)	6
D9 (mm)	5
D10 (mm)	8
E1	M5
F (mm)	8.0
F1 (mm)	30.0
H (mm)	38.0
H1 (mm)	42.5
H2 (mm)	18.5
K1	M8
L (mm)	29
L1 (mm)	18
L2 (mm)	30.0
L3 (mm)	16
L4 (mm)	9.9
T (mm)	8
T1 (mm)	20

T2 (mm)	4
SW1 (mm)	7