

Compact cylinders - Series 31

Product code: 31R3A020A040

Datasheet creation date: 07/03/2025 19:27

Check the most updated document online [click here](#)



TECHNICAL DATA

Series	31
Version	R=non-rotating with flange only double acting
Operation	3=double-acting through rod
Diameter (mm)	20
Stroke type	standard
Stroke (mm)	40
Rod seals material	-
Materials	A = rolled stainless steel AISI 303 rod tube profile aluminium
Construction	A = standard

Compact cylinders - Series 31

Product code: 31R3A020A040

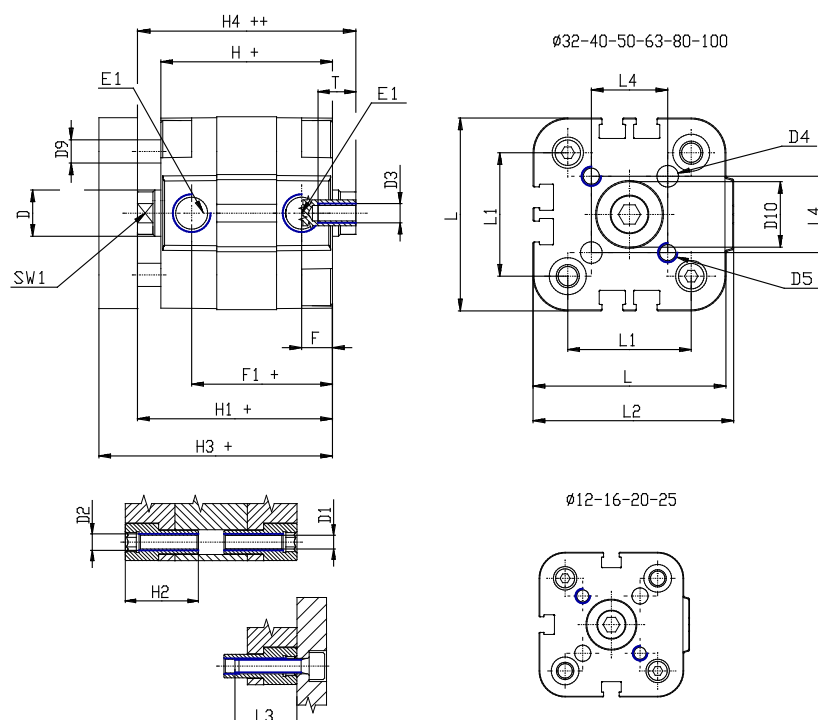

DIMENSIONS

Ø D (mm)	10
Ø D1 (mm)	4.5
D2	M5
D3	M5
Ø D4 (mm)	4
D5	M4
Ø D8 (mm)	6
D9 (mm)	6
D10 (mm)	10
E1	M5
F (mm)	8.0
F1 (mm)	30.0
H (mm)	38.0
H1 (mm)	42.5
H2 (mm)	18.5
K1	M10x1,25
L (mm)	36
L1 (mm)	22
L2 (mm)	37.5
L3 (mm)	18
L4 (mm)	12.0
T (mm)	10
T1 (mm)	22

T2 (mm)	4
SW1 (mm)	8