

Compact cylinder multiposition version - Series 32

Product code: 32F2A025A180/212N

Datasheet creation date: 08/03/2025 10:38

Check the most updated document online [click here](#)



TECHNICAL DATA

Series	32
Version	F=female rod thread
Materials	A = anodized aluminium profile, end blocks and piston
Diameter (mm)	25

Compact cylinder multiposition version - Series 32

Product code: 32F2A025A180/212N

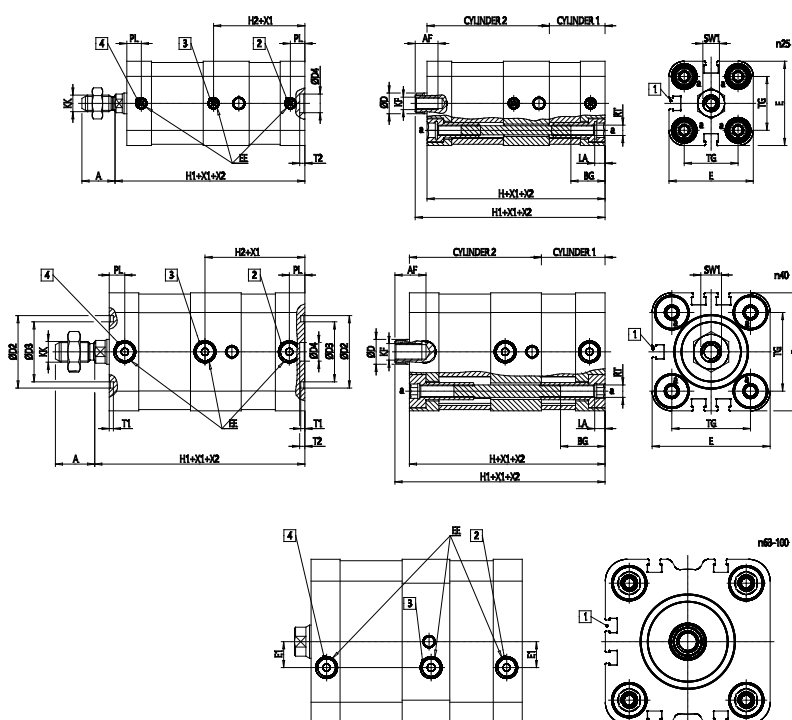

DIMENSIONS

A (mm)	16
AF (mm)	11
BG (mm)	16.5
ØD (mm)	10
D2 (mm)	0
D3 (mm)	0
D4 (mm)	9
E (mm)	40.7
EE	M5
E1 (mm)	0.0
H (mm)	76
H1 (mm)	81.7
H2 (mm)	44.0
KF	M6
KK	M8X1.25
LA (mm)	5
PL (mm)	7.0
SW1 (mm)	8
RT	M5
T1 (mm)	0
T2 (mm)	2.5
TG (mm)	26.0