

Compact magnetic cylinders - Series 32

Product code: 32F2A025A235

Datasheet creation date: 07/03/2025 23:36

Check the most updated document online [click here](#)



TECHNICAL DATA

Series	32
Ø cyl. (mm)	25
Version	F=female rod thread
Operation	2=double-acting
Materials	A = anodized aluminium body, end blocks and piston,
Construction	A = standard
Stroke type	V=variable
Stroke Cylinder (mm)	235
Rod seals material	Standard
Rod length (mm)	0

Compact magnetic cylinders - Series 32

Product code: 32F2A025A235

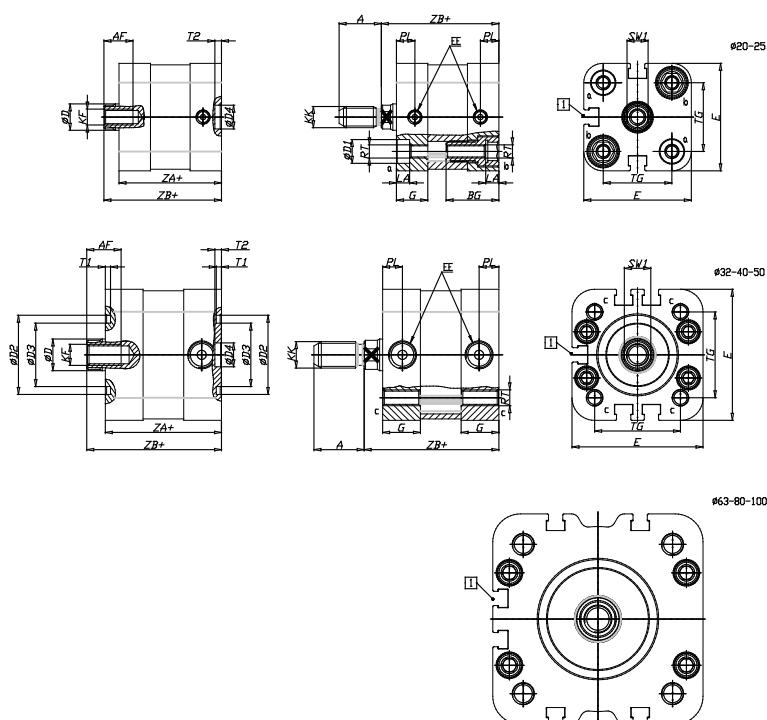

DIMENSIONS

A (mm)	16
AF (mm)	11
BG (mm)	20.0
G (mm)	11.9
Ø (mm)	10
Ø (mm)	9
D2 (mm)	0
D3 (mm)	0
D4 (mm)	9
D5 (mm)	6
D6 (mm)	14
D7	M5
D8 (mm)	5
E (mm)	40.7
EE	M5
H (mm)	8
KF	M6
KK	M8
LA (mm)	5
L4 (mm)	22
PL (mm)	7.0
RT	M5
SW1 (mm)	8

T1 (mm)	0
T2 (mm)	2
T3 (mm)	6.5
TG (mm)	26.0
ZA (mm)	38.8
ZB (mm)	44.5
ZC (mm)	50.2