

## Compact magnetic cylinders - Series 32

Product code: 32F2A100A080

Datasheet creation date: 07/03/2025 23:10

Check the most updated document online [click here](#)



### TECHNICAL DATA

<b>Series</b>	32
<b>Ø cyl. (mm)</b>	100
<b>Version</b>	F=female rod thread
<b>Operation</b>	2=double-acting
<b>Materials</b>	A = anodized aluminium body, end blocks and piston,
<b>Construction</b>	A = standard
<b>Stroke type</b>	V=variable
<b>Stroke Cylinder (mm)</b>	80
<b>Rod seals material</b>	Standard
<b>Rod length (mm)</b>	0

# Compact magnetic cylinders - Series 32

Product code: 32F2A100A080

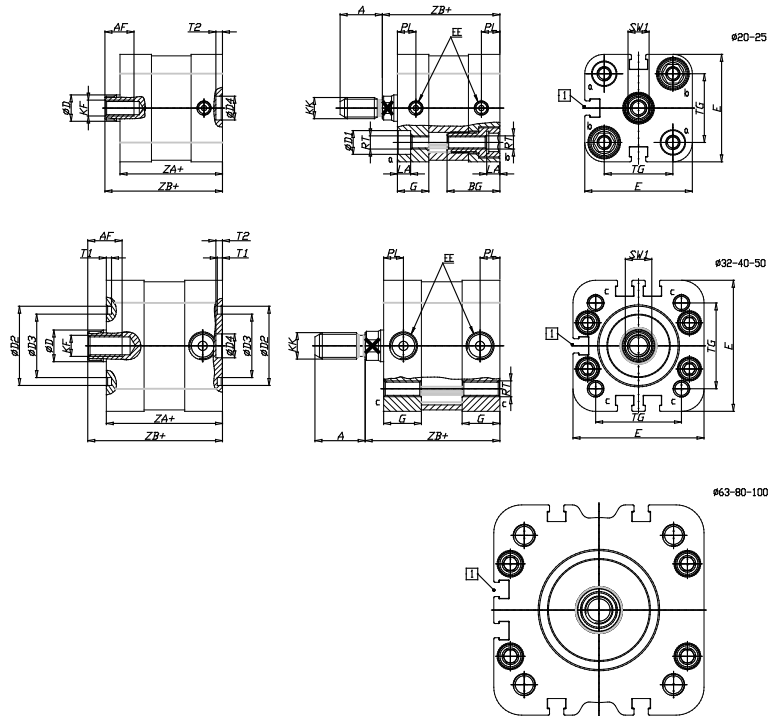

## DIMENSIONS

A (mm)	28
AF (mm)	20
BG (mm)	0.0
G (mm)	18
Ø (mm)	25
Ø (mm)	0
D2 (mm)	55
D3 (mm)	49
D4 (mm)	12
D5 (mm)	12
D6 (mm)	24
D7	M10
D8 (mm)	10
E (mm)	115.6
EE	G1/8
H (mm)	14
KF	M12
KK	M16x1,5
LA (mm)	0
L4 (mm)	80
PL (mm)	8.0
RT	M10
SW1 (mm)	22

T1 (mm)	2
T2 (mm)	4
T3 (mm)	10.5
TG (mm)	89.0
ZA (mm)	67.0
ZB (mm)	76.7
ZC (mm)	86.4