

Compact magnetic cylinders - Series 32

Product code: 32F2A100A120

Datasheet creation date: 07/03/2025 23:10

Check the most updated document online [click here](#)



TECHNICAL DATA

Series	32
Ø cyl. (mm)	100
Version	F=female rod thread
Operation	2=double-acting
Materials	A = anodized aluminium body, end blocks and piston,
Construction	A = standard
Stroke type	V=variable
Stroke Cylinder (mm)	120
Rod seals material	Standard
Rod length (mm)	0

Compact magnetic cylinders - Series 32

Product code: 32F2A100A120

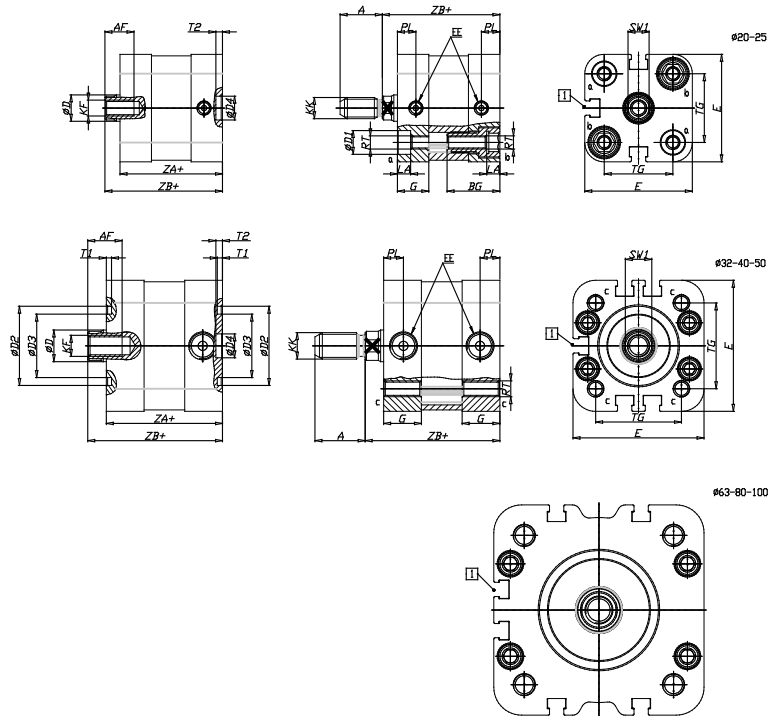

DIMENSIONS

A (mm)	28
AF (mm)	20
BG (mm)	0.0
G (mm)	18
Ø (mm)	25
Ø (mm)	0
D2 (mm)	55
D3 (mm)	49
D4 (mm)	12
D5 (mm)	12
D6 (mm)	24
D7	M10
D8 (mm)	10
E (mm)	115.6
EE	G1/8
H (mm)	14
KF	M12
KK	M16x1,5
LA (mm)	0
L4 (mm)	80
PL (mm)	8.0
RT	M10
SW1 (mm)	22

T1 (mm)	2
T2 (mm)	4
T3 (mm)	10.5
TG (mm)	89.0
ZA (mm)	67.0
ZB (mm)	76.7
ZC (mm)	86.4