

Compact cylinders Tandem version - Series 32

Product code: 32M2A040A125N2

Datasheet creation date: 08/03/2025 10:40

Check the most updated document online [click here](#)



TECHNICAL DATA

Series	32
Version	M=male rod thread
Materials	A = anodized aluminium profile, end blocks and piston
Diameter (mm)	40

Compact cylinders Tandem version - Series 32

Product code: 32M2A040A125N2

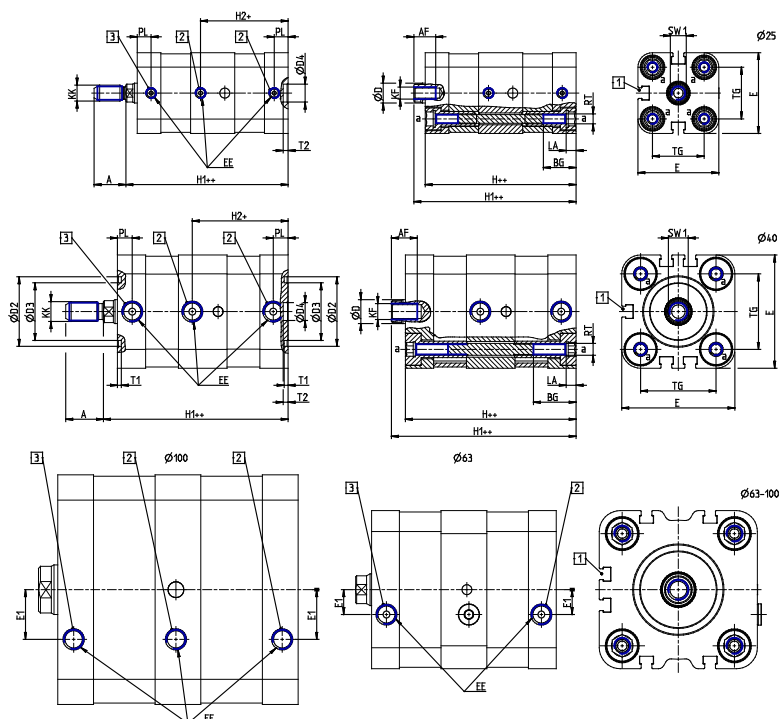

DIMENSIONS

A (mm)	19
AF (mm)	13
BG (mm)	21.5
ØD (mm)	12
D2 (mm)	35
D3 (mm)	29
D4 (mm)	9
E (mm)	57.0
EE	G1/8
E1 (mm)	0.0
H (mm)	86
H1 (mm)	93
H2 (mm)	48.2
KF	M8
KK (mm)	M10X1.25
LA (mm)	5
PL (mm)	7.6
RT	M6
SW1 (mm)	10
T1 (mm)	2
T2 (mm)	2.5
TG (mm)	38.0