

Compact cylinder multiposition version - Series 32

Product code: 32M2A063A170/340N

Datasheet creation date: 08/03/2025 10:43

Check the most updated document online [click here](#)



TECHNICAL DATA

Series	32
Version	M=male rod thread
Materials	A = anodized aluminium profile, end blocks and piston
Diameter (mm)	63

Compact cylinder multiposition version - Series 32

Product code: 32M2A063A170/340N

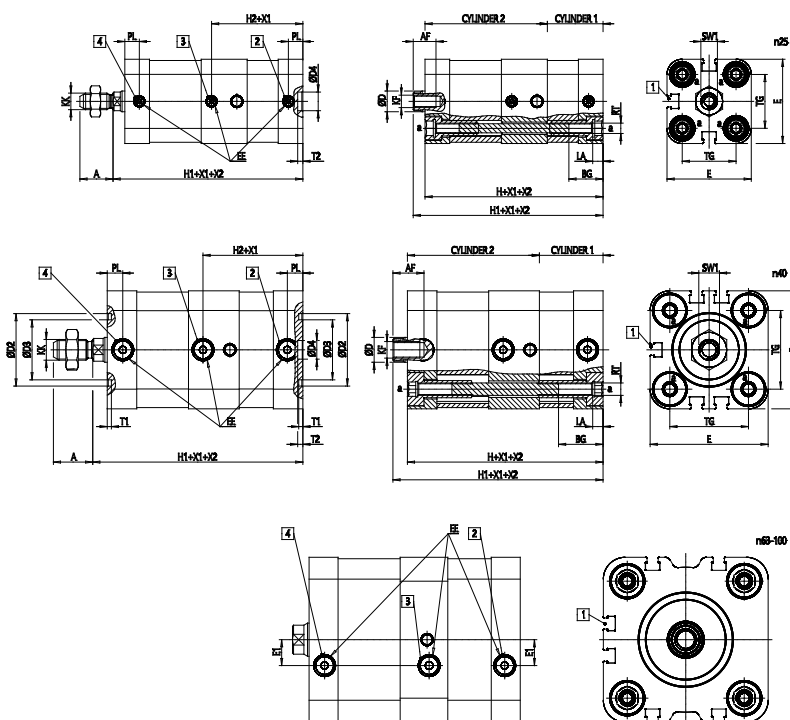

DIMENSIONS

A (mm)	22
AF (mm)	16
BG (mm)	18.5
ØD (mm)	16
D2 (mm)	45
D3 (mm)	39
D4 (mm)	12
E (mm)	79.6
EE	G1/8
E1 (mm)	12.5
H (mm)	93
H1 (mm)	101
H2 (mm)	44.0
KF	M10
KK	M12X1.25
LA (mm)	6
PL (mm)	7.6
SW1 (mm)	13
RT	M8
T1 (mm)	2
T2 (mm)	3.0
TG (mm)	56.5