

Compact cylinders Tandem version - Series 32

Product code: 32M2A100A100N3

Datasheet creation date: 08/03/2025 10:37

Check the most updated document online [click here](#)



TECHNICAL DATA

Series	32
Version	M=male rod thread
Materials	A = anodized aluminium profile, end blocks and piston
Diameter (mm)	100

Compact cylinders Tandem version - Series 32

Product code: 32M2A100A100N3

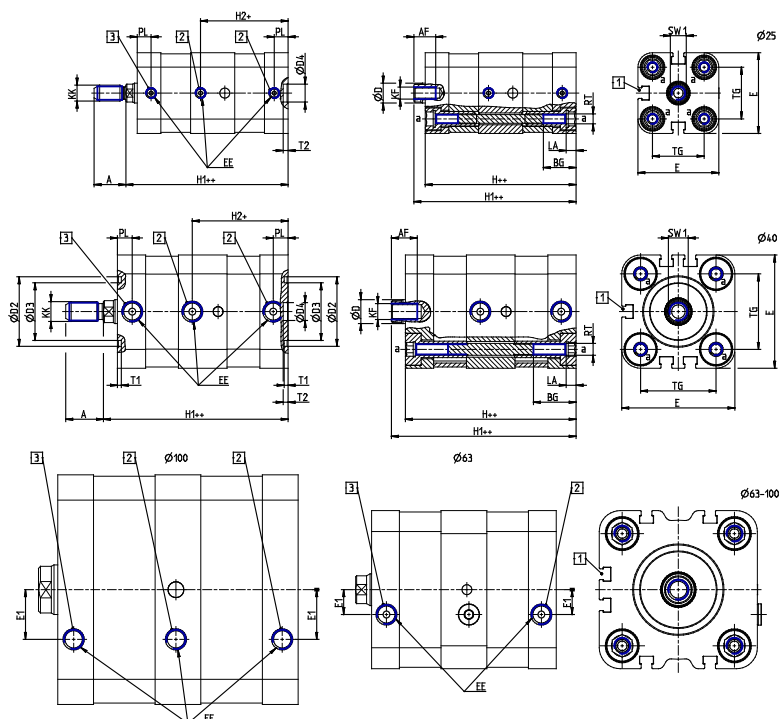

DIMENSIONS

A (mm)	28
AF (mm)	20
BG (mm)	20.0
ØD (mm)	25
D2 (mm)	55
D3 (mm)	49
D4 (mm)	12
E (mm)	115.6
EE	G1/8
E1 (mm)	25.0
H (mm)	121
H1 (mm)	130.7
H2 (mm)	60.5
KF	M12
KK (mm)	M16X1.5
LA (mm)	6
PL (mm)	8.0
RT	M10
SW1 (mm)	22
T1 (mm)	2
T2 (mm)	3.0
TG (mm)	89.0