

Compact magnetic cylinders - Series 32

Product code: 32R2A032A060

Datasheet creation date: 07/03/2025 23:06

Check the most updated document online [click here](#)



TECHNICAL DATA

Series	32
Ø cyl. (mm)	32
Version	R=non-rotating with flange only double acting
Operation	2=double-acting
Materials	A = anodized aluminium body, end blocks and piston,
Construction	A = standard
Stroke type	V=variable
Stroke Cylinder (mm)	60
Rod seals material	Standard
Rod length (mm)	0

Compact magnetic cylinders - Series 32

Product code: 32R2A032A060

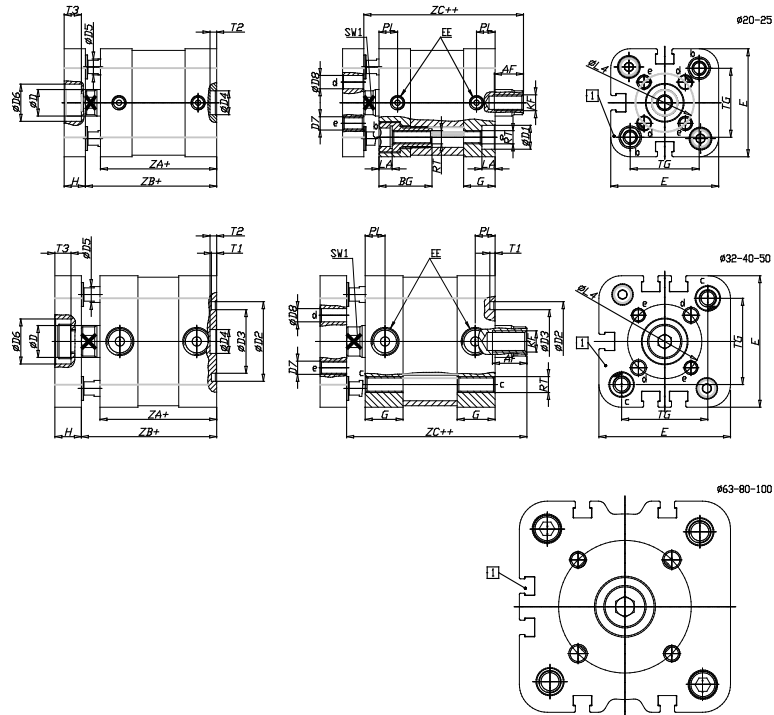

DIMENSIONS

A (mm)	19
AF (mm)	13
BG (mm)	0.0
G (mm)	14.3
Ø (mm)	12
Ø (mm)	0
D2 (mm)	30
D3 (mm)	24
D4 (mm)	9
D5 (mm)	6
D6 (mm)	17
D7	M5
D8 (mm)	5
E (mm)	49.6
EE	G1\8
H (mm)	10
KF	M8
KK	M10x1,25
LA (mm)	0
L4 (mm)	28
PL (mm)	7.6
RT	M6
SW1 (mm)	10

T1 (mm)	2
T2 (mm)	2
T3 (mm)	6
TG (mm)	32.5
ZA (mm)	44.0
ZB (mm)	51.0
ZC (mm)	58