

Compact magnetic cylinders - Series 32

Product code: 32R2A050A035

Datasheet creation date: 07/03/2025 23:08

Check the most updated document online [click here](#)



TECHNICAL DATA

Series	32
Ø cyl. (mm)	50
Version	R=non-rotating with flange only double acting
Operation	2=double-acting
Materials	A = anodized aluminium body, end blocks and piston,
Construction	A = standard
Stroke type	V=variable
Stroke Cylinder (mm)	35
Rod seals material	Standard
Rod length (mm)	0

Compact magnetic cylinders - Series 32

Product code: 32R2A050A035

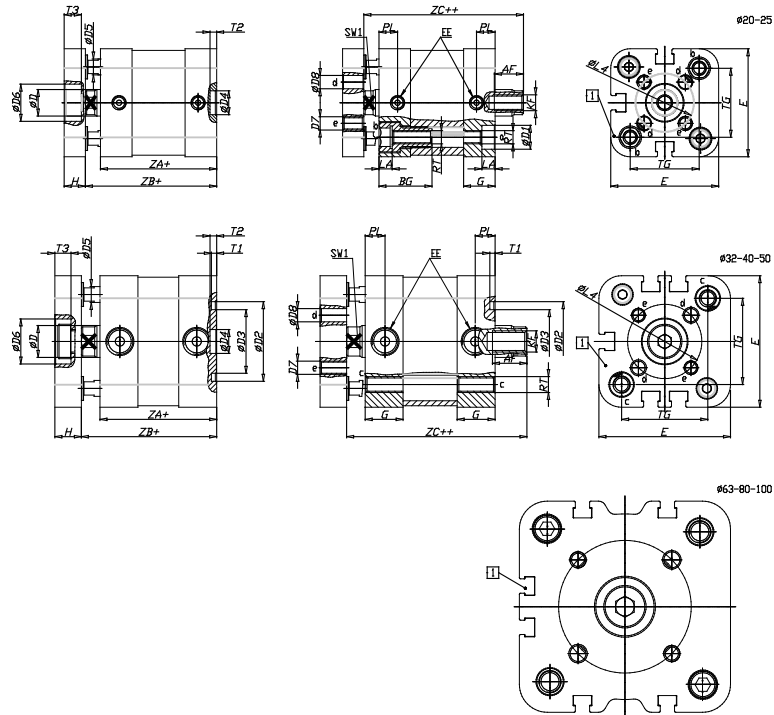

DIMENSIONS

A (mm)	22
AF (mm)	16
BG (mm)	0.0
G (mm)	14.3
Ø (mm)	16
Ø (mm)	0
D2 (mm)	40
D3 (mm)	34
D4 (mm)	12
D5 (mm)	10
D6 (mm)	22
D7	M6
D8 (mm)	6
E (mm)	69.6
EE	G1\8
H (mm)	12
KF	M10
KK	M12x1,25
LA (mm)	0
L4 (mm)	42
PL (mm)	7.6
RT	M8
SW1 (mm)	13

T1 (mm)	2
T2 (mm)	4
T3 (mm)	7
TG (mm)	46.5
ZA (mm)	45.0
ZB (mm)	53.0
ZC (mm)	61