

3/2-way solenoid valve, G1/4, monostable - Mod. 334... Mod 344... - Series 3

Product code: 334-015-02-U77

Datasheet creation date: 10/03/2025 10:56

Check the most updated document online [click here](#)



TECHNICAL DATA

Mod.	334-015-02
Mounting	In-line
Function	3/2NC
Flow rate (NI/min)	1300
Operating pressure	2.5 ÷ 10
Pilot pressure	-
Manual override	= bistable, standard
Dimensions of the solenoid	U7 = PET / 22 x 22
Solenoid voltage	7 = 24 V DC

3/2-way solenoid valve, G1/4, monostable - Mod. 334... Mod 344... - Series 3

Product code: 334-015-02-U77

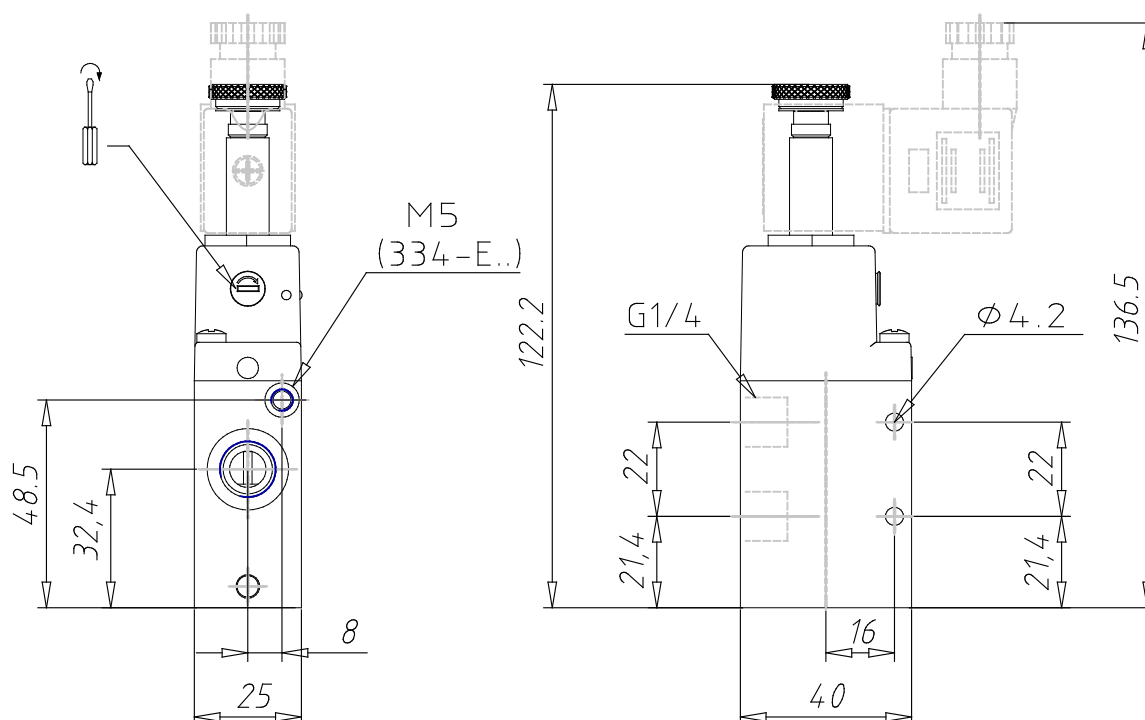

DIMENSIONS

Mod.	334-015-02
Mounting	In-line
Function	3/2NC
Flow rate (NI/min)	1300
Operating pressure	2.5 ÷ 10
Pilot pressure	-
Manual override	= bistable, standard
Dimensions of the solenoid	U7 = PET / 22 x 22
Solenoid voltage	7 = 24 V DC