

## 3/2 ways G1/8 solenoid valve, monostable - Series 3

Product code: 348-015-02-U77

Datasheet creation date: 10/03/2025 11:00

Check the most updated document online [click here](#)



### TECHNICAL DATA

<b>Mod.</b>	348-015-02
<b>Mounting</b>	in-line
<b>Function</b>	3/2 NC
<b>Flow rate (NI/min)</b>	700
<b>Operating pressure</b>	2.5-10
<b>Manual override</b>	= bistabile standard
<b>Dimensions of the solenoid</b>	U7 = PET / 22 x 22
<b>Solenoid voltage</b>	7 = 24 V DC

### 3/2 ways G1/8 solenoid valve, monostable - Series 3

Product code: 348-015-02-U77

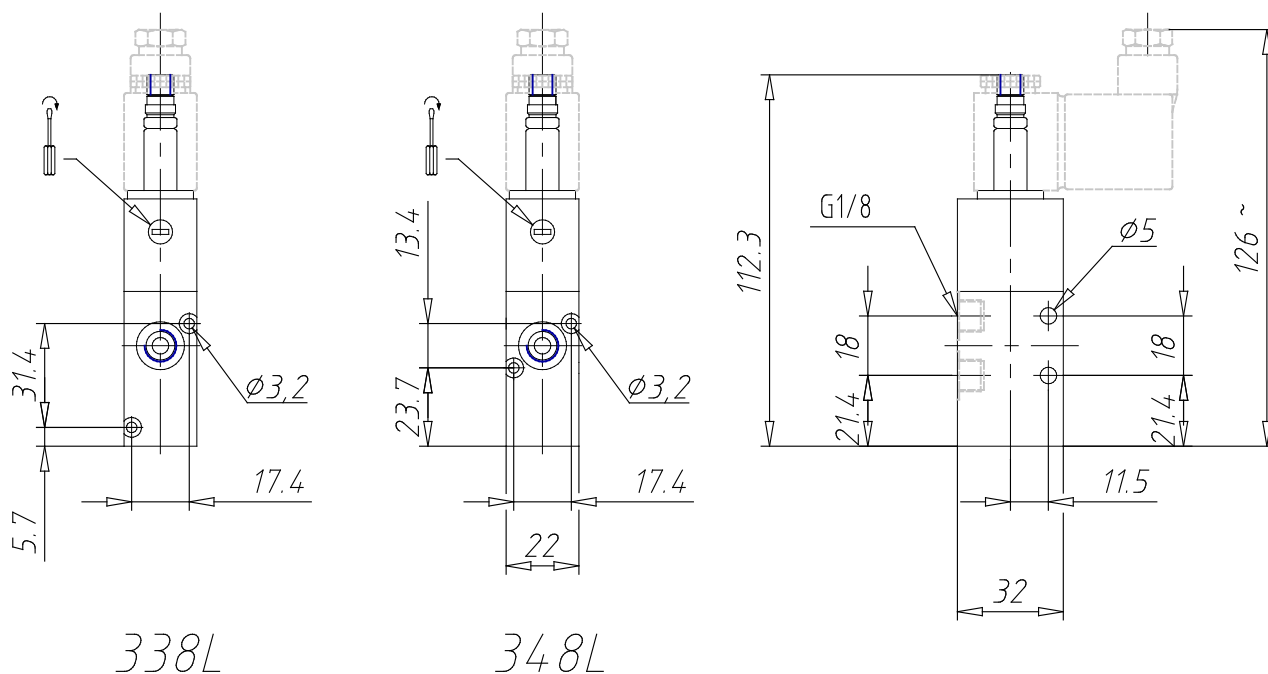

#### DIMENSIONS

<b>Mod.</b>	348-015-02
<b>Mounting</b>	in-line
<b>Function</b>	3/2 NC
<b>Flow rate (NI/min)</b>	700
<b>Operating pressure</b>	2.5-10
<b>Manual override</b>	= bistabile standard
<b>Dimensions of the solenoid</b>	U7 = PET / 22 x 22
<b>Solenoid voltage</b>	7 = 24 V DC