

Manually operated valves - Series 1,3,4

Product code: 368-905

Datasheet creation date: 10/03/2025 12:07

Check the most updated document online [click here](#)



TECHNICAL DATA

Mod.	368-905
Actuating force (N)	20
Operating pressure (bar)	-0.9+10
Flow rate (Nl/min)	700

Manually operated valves - Series 1,3,4

Product code: 368-905

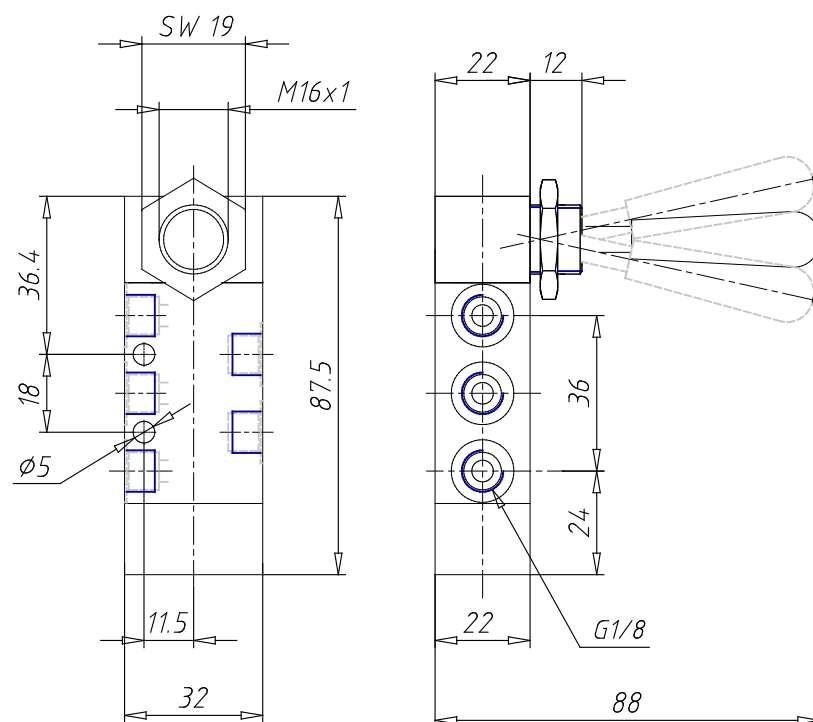

DIMENSIONS

Mod.	368-905
Actuating force (N)	20
Operating pressure (bar)	-0.9÷10
Flow rate (NI/min)	700