

## Manually operated valves - Series 1,3,4

Product code: 388-905

Datasheet creation date: 10/03/2025 12:08

Check the most updated document online [click here](#)



### TECHNICAL DATA

<b>Mod.</b>	388-905
<b>Actuating force (N)</b>	20
<b>Operating pressure (bar)</b>	-0.9+10
<b>Flow rate (Nl/min)</b>	700

## Manually operated valves - Series 1,3,4

Product code: 388-905

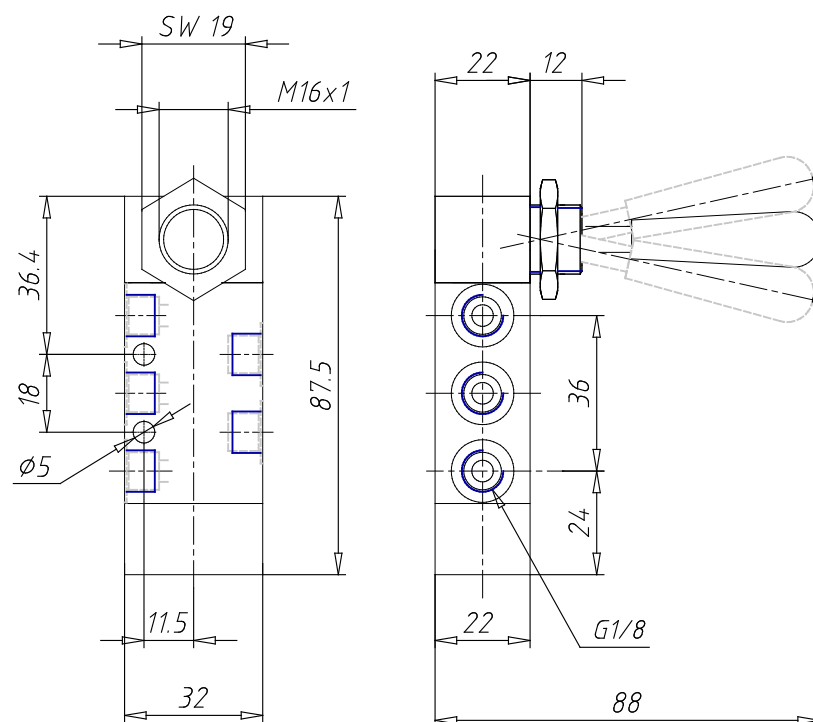

### DIMENSIONS

<b>Mod.</b>	388-905
<b>Actuating force (N)</b>	20
<b>Operating pressure (bar)</b>	-0.9÷10
<b>Flow rate (NI/min)</b>	700