

Electromechanical cylinders - Series 3E

Product code: 3E020BS0200P10M/PMA00

Datasheet creation date: 07/03/2025 16:57

Check the most updated document online [click here](#)



TECHNICAL DATA

Series	3E
Size (mm)	020
Screw pitch (mm)	P10 = 10mm
Stroke (mm)	200
Construction type	M = male rod thread
longer piston rod	0
Motor connection	PM = Kit Mod. PM
Motor	A = MTS 17
Brake	0 = without brake
Encoder	0 = without encoder
Type of communication	
Additional functions	

Electromechanical cylinders - Series 3E

Product code: 3E020BS0200P10M/PMA00

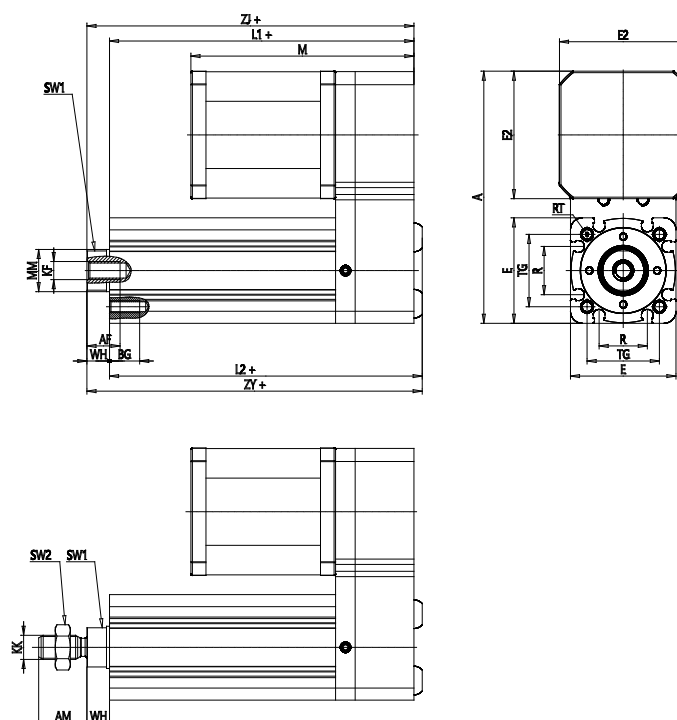

DIMENSIONS

AM (mm)	16
AF (mm)	11
B (mm)	28.5
BG (mm)	10
E (mm)	35
E2	42.5
F (mm)	5
KF	M6
M (mm)	74
A (mm)	84
KK (mm)	M8x1.25
L1 (mm)	301
L2 (mm)	304
MM (mm)	14
R (mm)	16
RT (mm)	M4
PL (mm)	19
SW1 (mm)	13
SW2 (mm)	13
TG (mm)	24.0
VA (mm)	6.5
TR (mm)	25.0
RC	M3

BC (mm)	10
VD (mm)	2
N (mm)	2.2
WH (mm)	7.5
ZJ (mm)	309.0
ZY (mm)	312