

Electromechanical cylinders - Series 3E

Product code: 3E032BS0050P03M(25)

Datasheet creation date: 07/03/2025 16:57

Check the most updated document online [click here](#)



TECHNICAL DATA

Series	3E
Size (mm)	032
Screw pitch (mm)	P03 = 3mm
Stroke (mm)	50
Construction type	M = male rod thread
longer piston rod	25
Motor connection	cylinder only
Motor	
Brake	
Encoder	
Type of communication	
Additional functions	

Electromechanical cylinders - Series 3E

Product code: 3E032BS0050P03M(25)

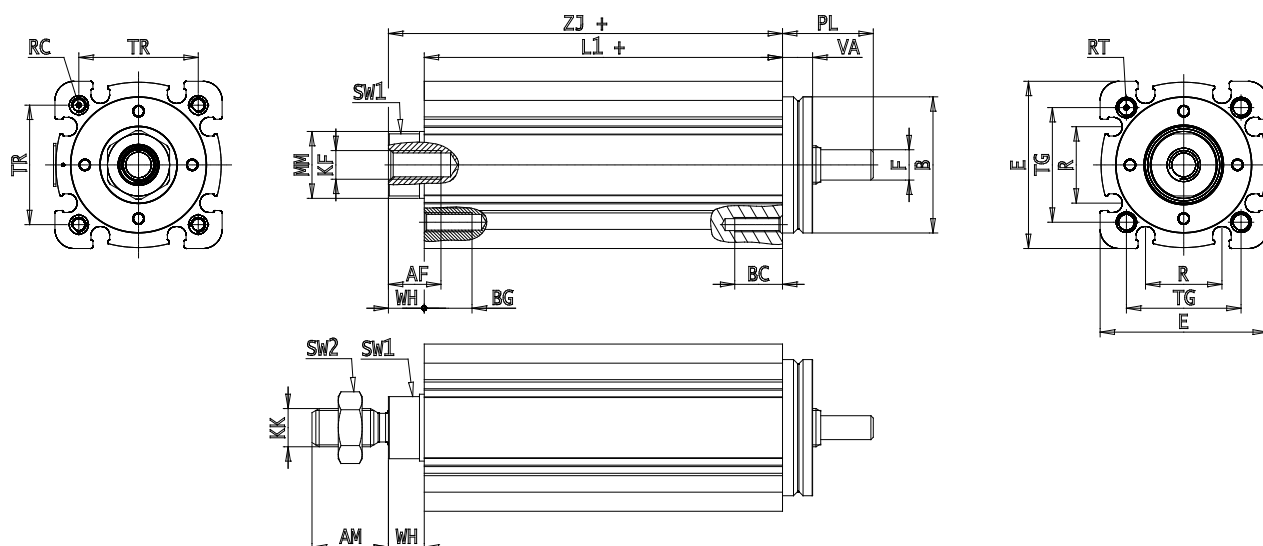

DIMENSIONS

AM (mm)	19
AF (mm)	13
B (mm)	34.0
BG (mm)	10
E (mm)	42
E2	0.0
F (mm)	5
KF	M8
M (mm)	0
A (mm)	0
KK (mm)	M10x1.25
L1 (mm)	125
L2 (mm)	0
MM (mm)	14
R (mm)	19
RT (mm)	M5
PL (mm)	19
SW1 (mm)	13
SW2 (mm)	17
TG (mm)	32.5
VA (mm)	5.5
TR (mm)	32.5
RC	M5

BC (mm)	10
VD (mm)	2
N (mm)	2.2
WH (mm)	7.5
ZJ (mm)	132.5
ZY (mm)	0