

## Electromechanical cylinders - Series 3E

Product code: 3E032BS0160P03M

Datasheet creation date: 07/03/2025 16:58

Check the most updated document online [click here](#)



### TECHNICAL DATA

<b>Series</b>	3E
<b>Size (mm)</b>	032
<b>Screw pitch (mm)</b>	P03 = 3mm
<b>Stroke (mm)</b>	160
<b>Construction type</b>	M = male rod thread
<b>longer piston rod</b>	0
<b>Motor connection</b>	cylinder only
<b>Motor</b>	
<b>Brake</b>	
<b>Encoder</b>	
<b>Type of communication</b>	
<b>Additional functions</b>	

## Electromechanical cylinders - Series 3E

Product code: 3E032BS0160P03M

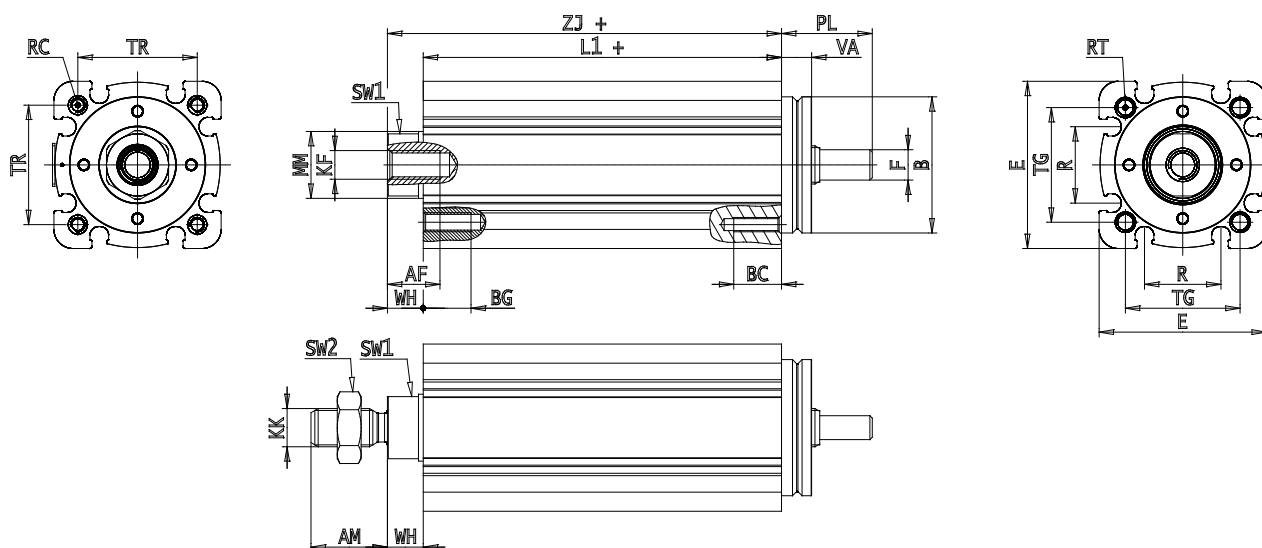

### DIMENSIONS

AM (mm)	19
AF (mm)	13
B (mm)	34.0
BG (mm)	10
E (mm)	42
E2	0.0
F (mm)	5
KF	M8
M (mm)	0
A (mm)	0
KK (mm)	M10x1.25
L1 (mm)	235
L2 (mm)	0
MM (mm)	14
R (mm)	19
RT (mm)	M5
PL (mm)	19
SW1 (mm)	13
SW2 (mm)	17
TG (mm)	32.5
VA (mm)	5.5
TR (mm)	32.5
RC	M5

BC (mm)	10
VD (mm)	2
N (mm)	2.2
WH (mm)	7.5
ZJ (mm)	242.5
ZY (mm)	0