

Cylinders ISO 15552 (ex DIN/ISO 6431 / VDMA 24562) - Series 40K

Product code: 40K2L200F0700

Datasheet creation date: 08/03/2025 10:57

Check the most updated document online [click here](#)



TECHNICAL DATA

Series (mm)	40
Version	K = standard, magnetic
Operation	2 = double-acting (front and rear cushions)
Materials	L = rolled stainless steel rod AISI 420B anodized aluminium round tube NBR seals
Ø (mm)	200
Construction	F = cylinder with centre trunnion
Stroke type	standard
Stroke (mm)	700
Option	Standard
extended piston (mm)	0
Certifications	Standard

Cylinders ISO 15552 (ex DIN/ISO 6431 / VDMA 24562) - Series 40K

Product code: 40K2L200F0700

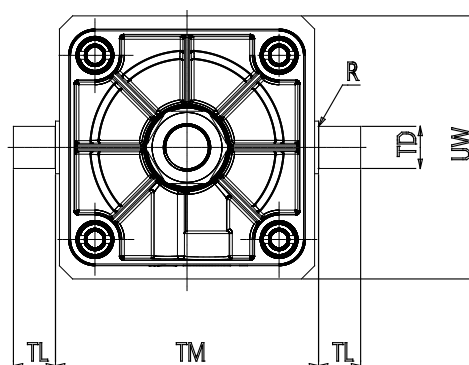
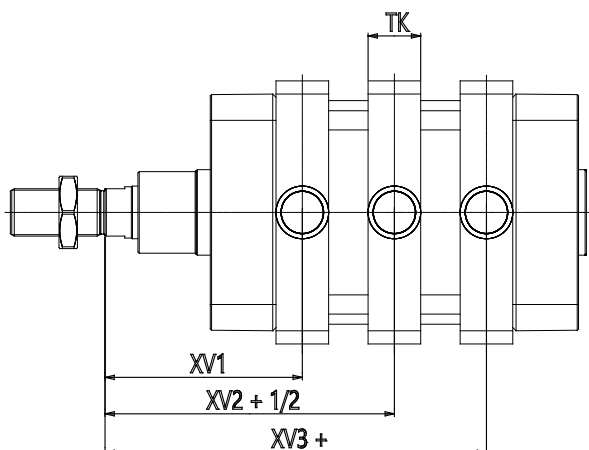

DIMENSIONS

Ø (mm)	40
KK	M36x2
Ø D11 (mm)	75
PL (mm)	25.5
G (mm)	15
L1 (mm)	65
AM (mm)	72
VA (mm)	8
EE	G3/4
WH (mm)	95
L2 (mm)	275.000
ZJ (mm)	275
VD (mm)	6
N (mm)	45.0
RT	M16
BG (mm)	24
TG (mm)	175
E (mm)	220
SW1 (mm)	36
SW3 (mm)	4
SW4 (mm)	55
Cushioning stroke (mm)	48
XV1±2 (mm)	160

XV2±2 (mm)	185
XV3±2 (mm)	210
h14 (mm)	250
TK (mm)	40
e9 (mm)	32
h14 (mm)	32
UW (mm)	250
R (mm)	0.2