

## Cylinders ISO 15552 (ex DIN/ISO 6431 / VDMA 24562) - Series 41K

Product code: 41K2P160A0385

Datasheet creation date: 08/03/2025 11:03

Check the most updated document online [click here](#)



### TECHNICAL DATA

<b>Series (mm)</b>	41
<b>Version</b>	K = standard, magnetic
<b>Operation</b>	2 = double-acting (front and rear cushions)
<b>Materials</b>	P = rolled stainless steel rod AISI 420B anodized aluminium round tube NBR seals
<b>Ø (mm)</b>	160
<b>Construction</b>	A = standard
<b>Stroke</b>	variable
<b>Stroke (mm)</b>	385
<b>Option</b>	Standard
<b>extended piston (mm)</b>	0
<b>Certifications</b>	Standard

## Cylinders ISO 15552 (ex DIN/ISO 6431 / VDMA 24562) - Series 41K

Product code: 41K2P160A0385

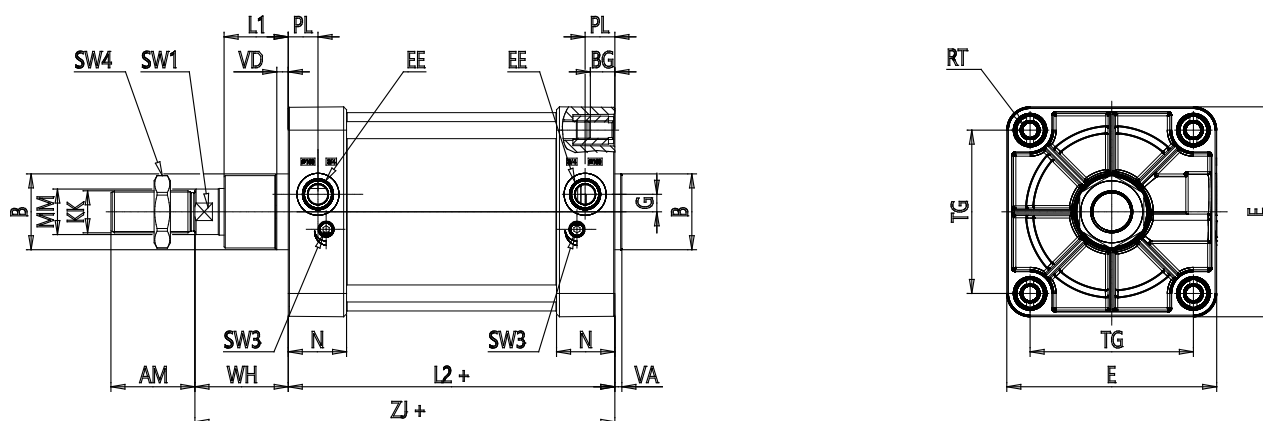

### DIMENSIONS

Ø MM (mm)	40
KK	M36x2
Ø D11 (mm)	65
PL (mm)	25.5
G (mm)	15
L1 (mm)	55
AM (mm)	72
VA (mm)	6
EE	G3/4
WH (mm)	80
L2 (mm)	260.000
ZJ	260
VD (mm)	6
N (mm)	45
RT	M16
BG (mm)	24
TG (mm)	140
E (mm)	180
SW1 (mm)	36
SW3 (mm)	4
SW4 (mm)	55
Cushioning stroke (mm)	33