

Cylinders ISO 15552 (ex DIN/ISO 6431 / VDMA 24562) - Series 41K

Product code: 41K6P160A0050

Datasheet creation date: 08/03/2025 11:04

Check the most updated document online [click here](#)



TECHNICAL DATA

Series (mm)	41
Version	K = standard, magnetic
Operation	6 = double-acting (through-rod with front and rear cushions)
Materials	P = rolled stainless steel rod AISI 420B anodized aluminium round tube NBR seals
Ø (mm)	160
Construction	A = standard
Stroke	standard
Stroke (mm)	50
Option	Standard
extended piston (mm)	0
Certifications	Standard

Cylinders ISO 15552 (ex DIN/ISO 6431 / VDMA 24562) - Series 41K

Product code: 41K6P160A0050

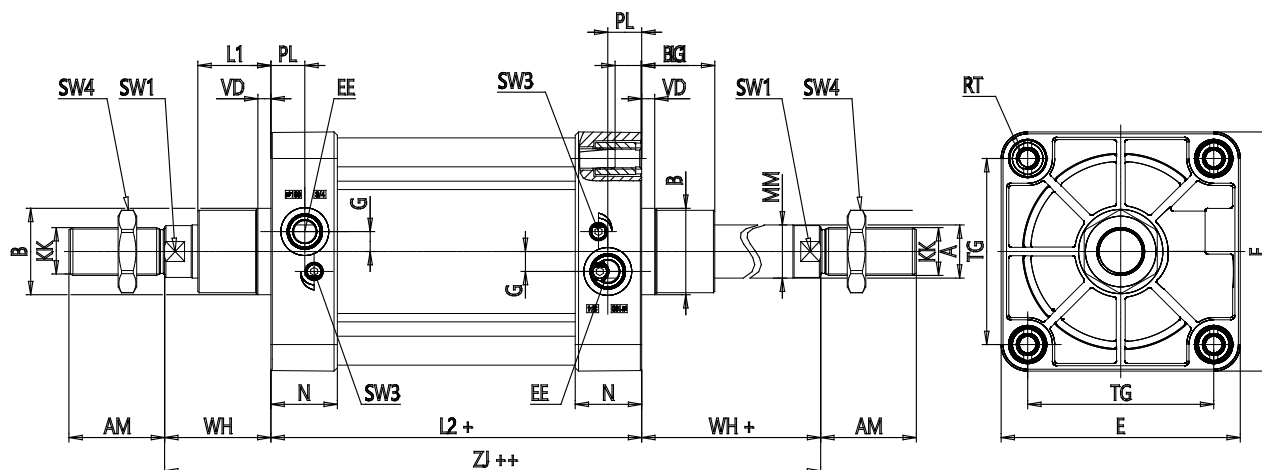

DIMENSIONS

Ø MM (mm)	40
KK	M36x2
Ø D11 (mm)	65
PL (mm)	25.5
G (mm)	15
L1 (mm)	55
AM (mm)	72
VA (mm)	6
EE	G3/4
WH (mm)	80
L2 (mm)	340.000
ZJ	260
VD (mm)	6
N (mm)	45
RT	M16
BG (mm)	24
TG (mm)	140
E (mm)	180
SW1 (mm)	36
SW3 (mm)	4
SW4 (mm)	55
Cushioning stroke (mm)	33