

Hydraulic brakes - Series 43

Product code: 43N-LT0-40-090

Datasheet creation date: 10/03/2025 00:31

Check the most updated document online [click here](#)



TECHNICAL DATA

Series	43
Diameter (mm)	40
Version	N = standard
Bowl	L = tank in series
Regulation	T = traction (rod thrust regulated)
Valve	0 = standard
Stroke (mm)	90

Hydraulic brakes - Series 43

Product code: 43N-LT0-40-090

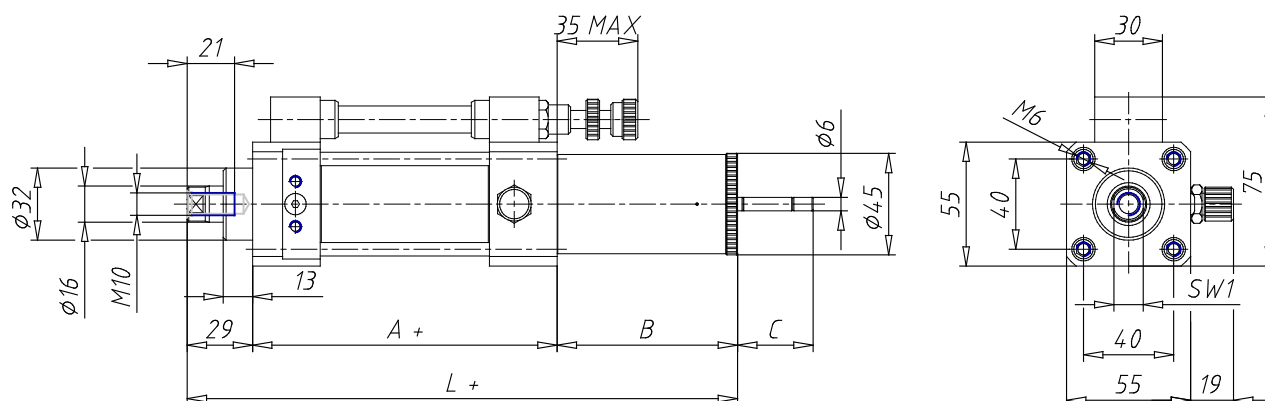

DIMENSIONS

A (mm)	85
B (mm)	80
C (mm)	32
L (mm)	194
SW1 (mm)	13