

Hydraulic brakes - Series 43

Product code: 43N-LTA-40-200

Datasheet creation date: 10/03/2025 00:32

Check the most updated document online [click here](#)



TECHNICAL DATA

Series	43
Diameter (mm)	40
Version	N = standard
Bowl	L = tank in series
Regulation	T = traction (rod thrust regulated)
Valve	A = SKIP valve
Stroke (mm)	200

Hydraulic brakes - Series 43

Product code: 43N-LTA-40-200

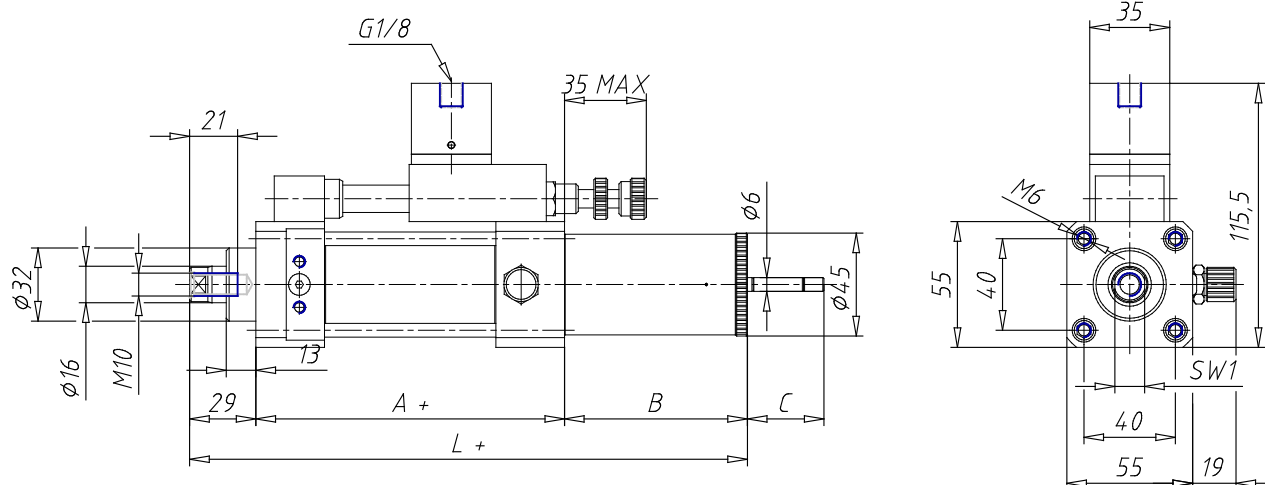

DIMENSIONS

A (mm)	85
B (mm)	100
C (mm)	47
L (mm)	214
SW1 (mm)	13