

Hydraulic brakes - Series 43

Product code: 43N-LTB-40-120

Datasheet creation date: 10/03/2025 00:33

Check the most updated document online [click here](#)



TECHNICAL DATA

Series	43
Diameter (mm)	40
Version	N = standard
Bowl	L = tank in series
Regulation	T = traction (rod thrust regulated)
Valve	B = SKIP + STOP valve
Stroke (mm)	120

Hydraulic brakes - Series 43

Product code: 43N-LTB-40-120

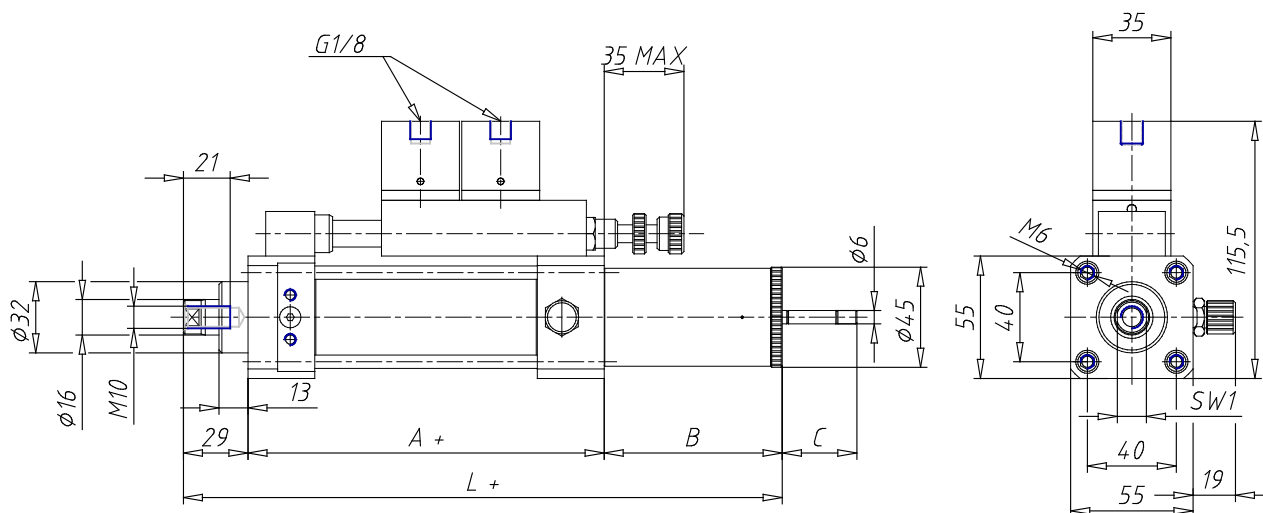

DIMENSIONS

A (mm)	85
B (mm)	80
C (mm)	32
L (mm)	214
SW1 (mm)	13