

Hydraulic brakes - Series 43

Product code: 43N-LTV-40-400

Datasheet creation date: 10/03/2025 00:33

Check the most updated document online [click here](#)



TECHNICAL DATA

Series	43
Diameter (mm)	40
Version	N = standard
Bowl	L = tank in series
Regulation	T = traction (rod thrust regulated)
Valve	V = STOP valve
Stroke (mm)	400

Hydraulic brakes - Series 43

Product code: 43N-LTV-40-400

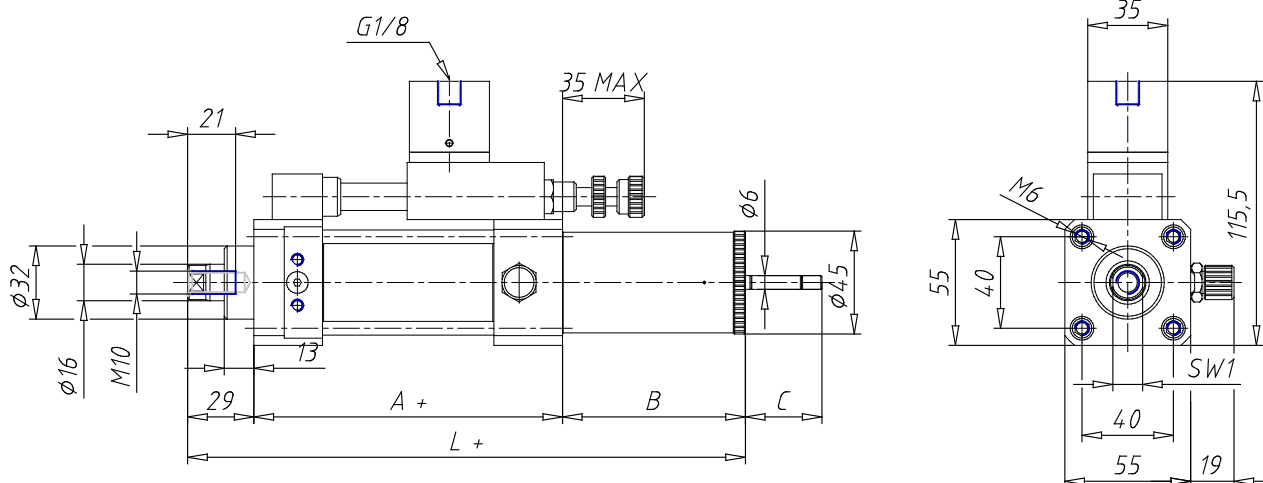

DIMENSIONS

A (mm)	85
B (mm)	145
C (mm)	86
L (mm)	214
SW1 (mm)	13