

Hydraulic brakes - Series 43

Product code: 43N-PS0-40-070

Datasheet creation date: 10/03/2025 00:34

Check the most updated document online [click here](#)



TECHNICAL DATA

| | |
|----------------------|-----------------------------------|
| Series | 43 |
| Diameter (mm) | 40 |
| Version | N = standard |
| Bowl | P = tank parallel |
| Regulation | S = thrust (rod return regulated) |
| Valve | 0 = standard |
| Stroke (mm) | 70 |

Hydraulic brakes - Series 43

Product code: 43N-PS0-40-070

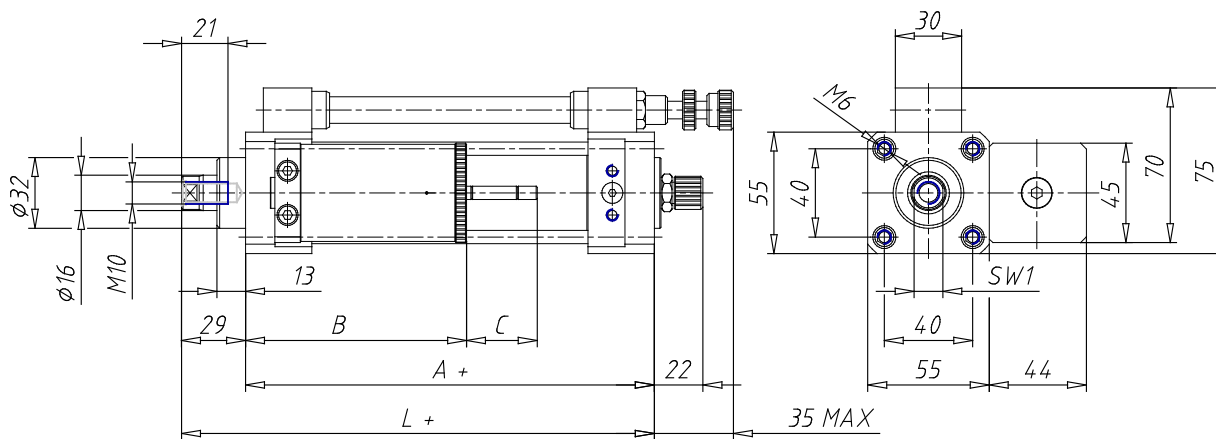

DIMENSIONS

| | |
|-----------------|-----|
| A (mm) | 85 |
| B (mm) | 105 |
| C (mm) | 32 |
| L (mm) | 114 |
| SW1 (mm) | 13 |