

Hydraulic brakes - Series 43

Product code: 43N-PT0-40-800

Datasheet creation date: 10/03/2025 00:38

Check the most updated document online [click here](#)



TECHNICAL DATA

Series	43
Diameter (mm)	40
Version	N = standard
Bowl	P = tank parallel
Regulation	T = traction (rod thrust regulated)
Valve	0 = standard
Stroke (mm)	800

Hydraulic brakes - Series 43

Product code: 43N-PT0-40-800

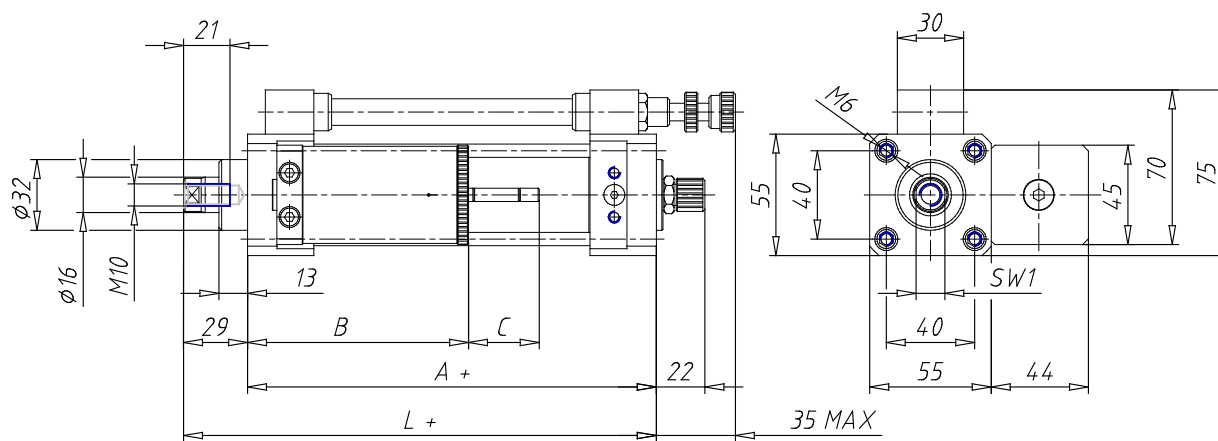

DIMENSIONS

A (mm)	85
B (mm)	170
C (mm)	86
L (mm)	114
SW1 (mm)	13