

Hydraulic brakes - Series 43

Product code: 43N-PTA-40-250

Datasheet creation date: 10/03/2025 00:38

Check the most updated document online [click here](#)



TECHNICAL DATA

Series	43
Diameter (mm)	40
Version	N = standard
Bowl	P = tank parallel
Regulation	T = traction (rod thrust regulated)
Valve	A = SKIP valve
Stroke (mm)	250

Hydraulic brakes - Series 43

Product code: 43N-PTA-40-250

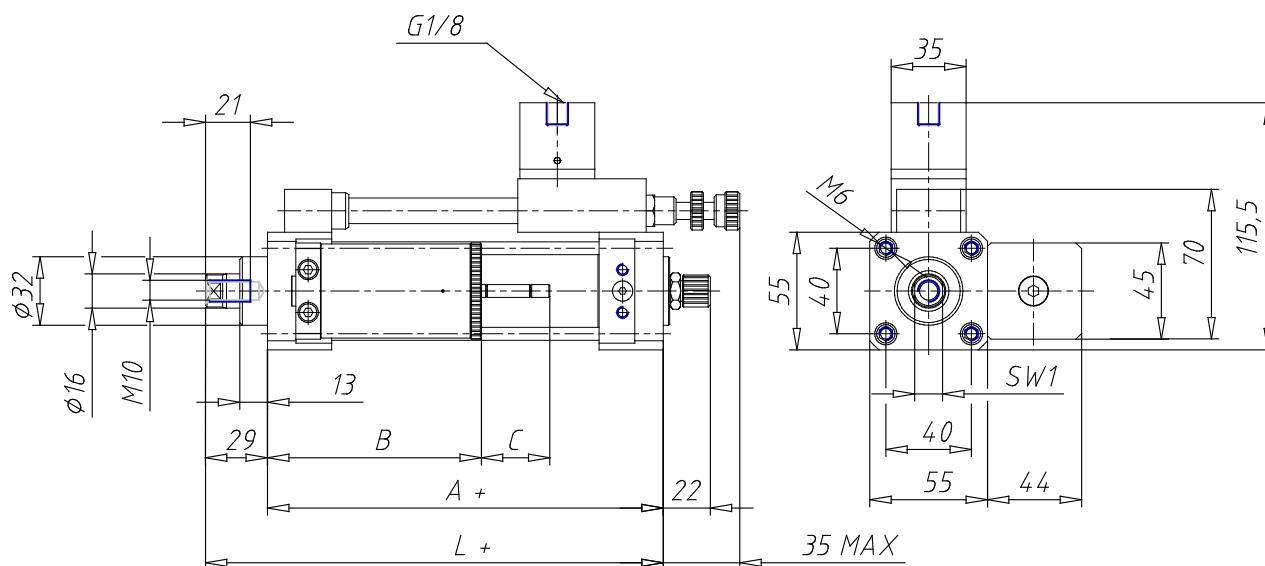

DIMENSIONS

A (mm)	85
B (mm)	150
C (mm)	67
L (mm)	114
SW1 (mm)	13