

Hydraulic brakes - Series 43

Product code: 43N-PTB-40-100

Datasheet creation date: 10/03/2025 00:39

Check the most updated document online [click here](#)



TECHNICAL DATA

Series	43
Diameter (mm)	40
Version	N = standard
Bowl	P = tank parallel
Regulation	T = traction (rod thrust regulated)
Valve	B = SKIP + STOP valve
Stroke (mm)	100

Hydraulic brakes - Series 43

Product code: 43N-PTB-40-100

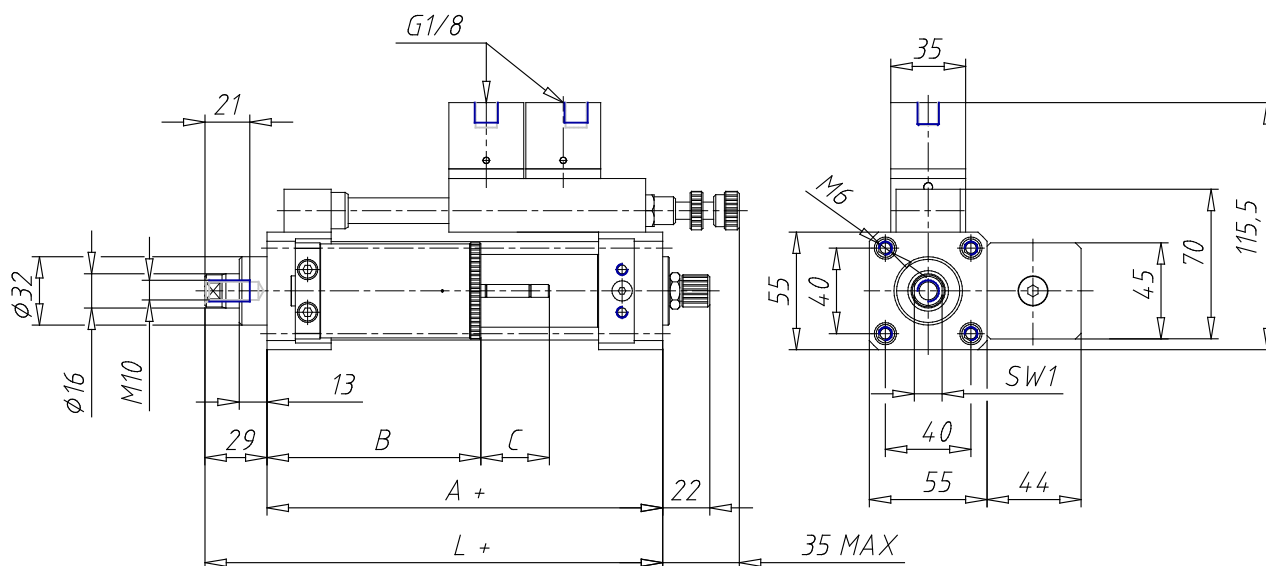

DIMENSIONS

A (mm)	85
B (mm)	105
C (mm)	32
L (mm)	114
SW1 (mm)	13