

## Hydraulic brakes - Series 43

Product code: 43N-PTB-40-350

Datasheet creation date: 10/03/2025 00:39

Check the most updated document online [click here](#)



### TECHNICAL DATA

<b>Series</b>	43
<b>Diameter (mm)</b>	40
<b>Version</b>	N = standard
<b>Bowl</b>	P = tank parallel
<b>Regulation</b>	T = traction (rod thrust regulated)
<b>Valve</b>	B = SKIP + STOP valve
<b>Stroke (mm)</b>	350

## Hydraulic brakes - Series 43

Product code: 43N-PTB-40-350

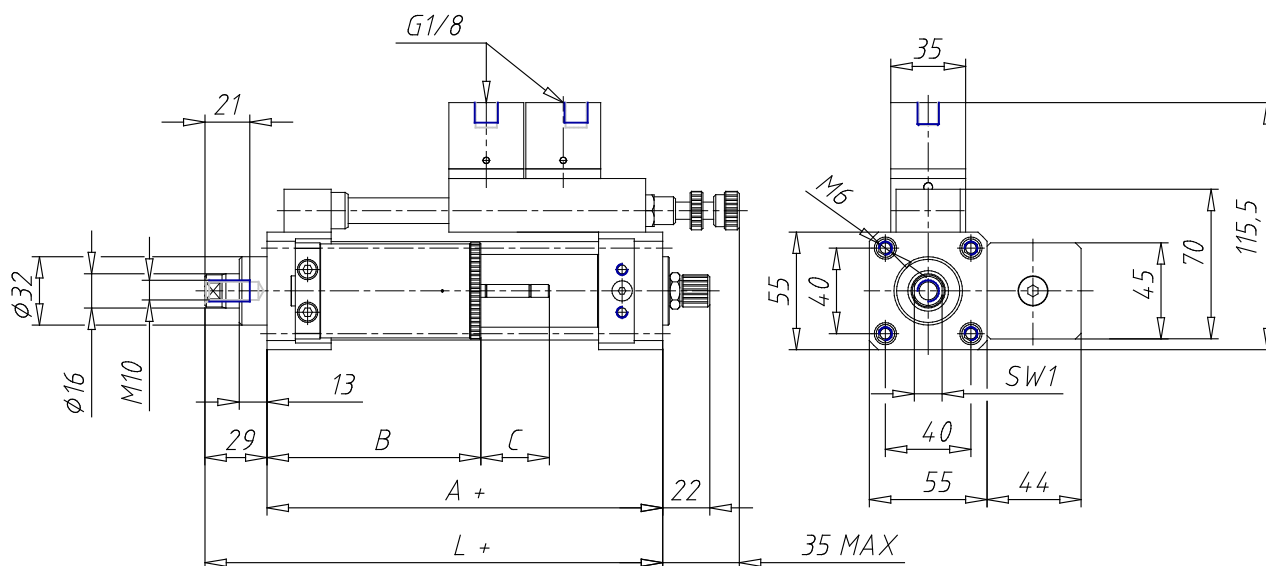

### DIMENSIONS

<b>A (mm)</b>	85
<b>B (mm)</b>	170
<b>C (mm)</b>	86
<b>L (mm)</b>	114
<b>SW1 (mm)</b>	13