

5/2-way solenoid valve, G1/4, monostable - Series 4

Product code: 454-016-22

Datasheet creation date: 10/03/2025 11:59

Check the most updated document online [click here](#)

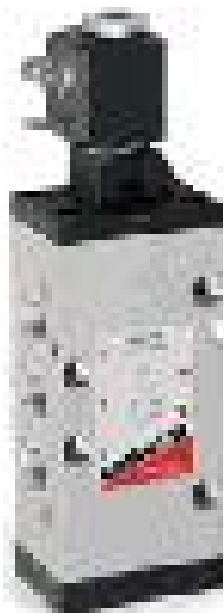

TECHNICAL DATA

Mod.	454-016-22
Function	5/2
Flow rate (NI/min)	1250
Operating pressure	2.5 ÷ 10
Type of manual override	= bistable, standard
Dimensions of the solenoid	No solenoid
Solenoid voltage	

5/2-way solenoid valve, G1/4, monostable - Series 4

Product code: 454-016-22

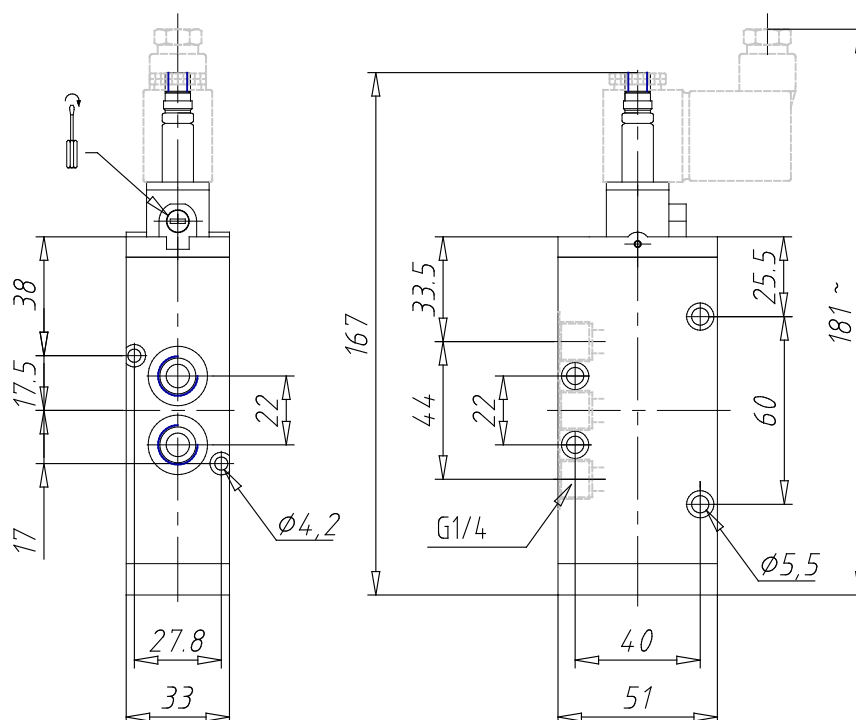

DIMENSIONS

Mod.	454-016-22
Function	5/2
Flow rate (NI/min)	1250
Operating pressure	2.5 ÷ 10
Type of manual override	= bistable, standard
Dimensions of the solenoid	No solenoid
Solenoid voltage	