

Anti-rotation guide units - Series 45

Product code: 45NHB020A0350

Datasheet creation date: 10/03/2025 02:17

Check the most updated document online [click here](#)



TECHNICAL DATA

Series	45
Diameter (mm)	20
Version	N = standard
Operation	HB = "H" ball guide
Materials	A = anodized aluminium body, hardened steel columns C50
Stroke (mm)	350

Anti-rotation guide units - Series 45

Product code: 45NHB020A0350

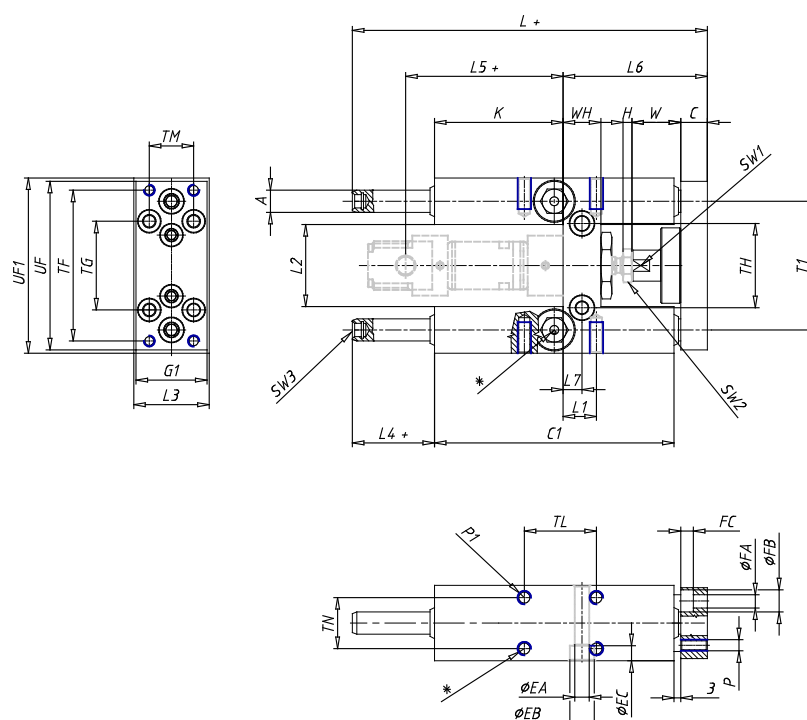

DIMENSIONS

TF (mm)	68
TG (mm)	40.0
TH (mm)	38.0
TI (mm)	58
TM (mm)	20
TL (mm)	32.5
TN (mm)	23
UF1 (mm)	79
UF (mm)	76
G1 (mm)	32
A (mm)	10
WH (mm)	17
C1 (mm)	108
H (mm)	4
W (mm)	22
C (mm)	12
K (mm)	58
L (mm)	160.0
L1 (mm)	15
L2 (mm)	37.0
L3 (mm)	34
L4 (mm)	37
L5 (mm)	71.0

L6 (mm)	65.0
L7 (mm)	8.5
L8 (mm)	0
P	M5
P1	M6
T (mm)	14
EA (mm)	6.5
EB (mm)	11
EC (mm)	6.8
FA (mm)	5.5
FB (mm)	10.0
FC (mm)	5.7
SW1 (mm)	13
SW2 (mm)	13
SW3 (mm)	4