

## Anti-rotation guide units - Series 45

Product code: 45NHB025A0060

Datasheet creation date: 10/03/2025 02:17

Check the most updated document online [click here](#)



### TECHNICAL DATA

<b>Series</b>	45
<b>Diameter (mm)</b>	25
<b>Version</b>	N = standard
<b>Operation</b>	HB = "H" ball guide
<b>Materials</b>	A = anodized aluminium body, hardened steel columns C50
<b>Stroke (mm)</b>	60

## Anti-rotation guide units - Series 45

Product code: 45NHB025A0060

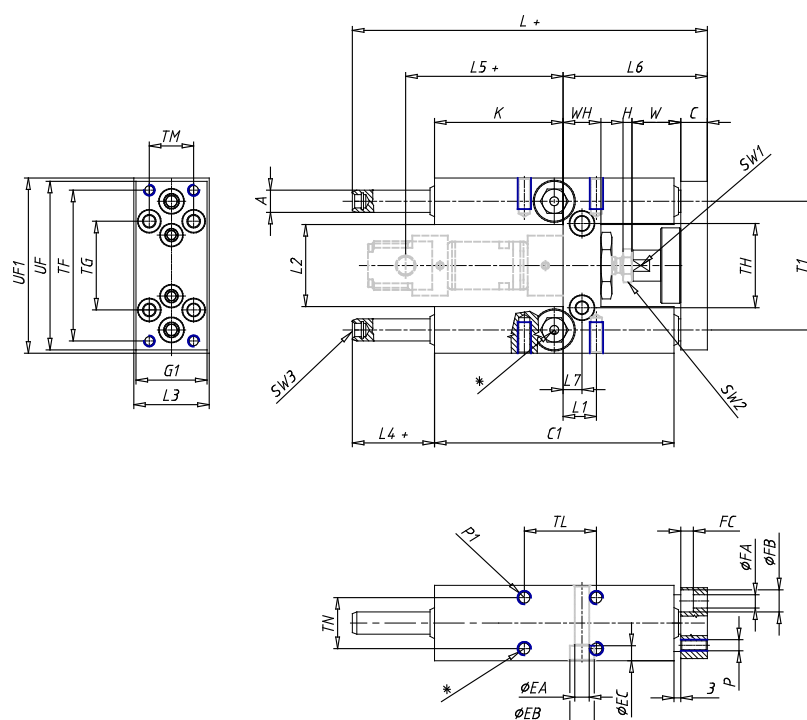

### DIMENSIONS

TF (mm)	68
TG (mm)	40.0
TH (mm)	38.0
TI (mm)	58
TM (mm)	20
TL (mm)	32.5
TN (mm)	23
UF1 (mm)	79
UF (mm)	76
G1 (mm)	32
A (mm)	10
WH (mm)	17
C1 (mm)	108
H (mm)	6
W (mm)	17
C (mm)	12
K (mm)	58
L (mm)	160.0
L1 (mm)	15
L2 (mm)	37.0
L3 (mm)	34
L4 (mm)	37
L5 (mm)	76.0

L6 (mm)	65.0
L7 (mm)	8.5
L8 (mm)	0
P	M5
P1	M6
T (mm)	14
EA (mm)	6.5
EB (mm)	11
EC (mm)	6.8
FA (mm)	5.5
FB (mm)	10.0
FC (mm)	5.7
SW1 (mm)	13
SW2 (mm)	17
SW3 (mm)	4