

Anti-rotation guide units - Series 45

Product code: 45NHT020A0050

Datasheet creation date: 10/03/2025 02:03

Check the most updated document online [click here](#)



TECHNICAL DATA

Series	45
Diameter (mm)	20
Version	N = standard
Operation	HT = "H" self lubricating guide
Materials	A = anodized aluminium body, stainless steel columns AISI 420B
Stroke (mm)	50

Anti-rotation guide units - Series 45

Product code: 45NHT020A0050

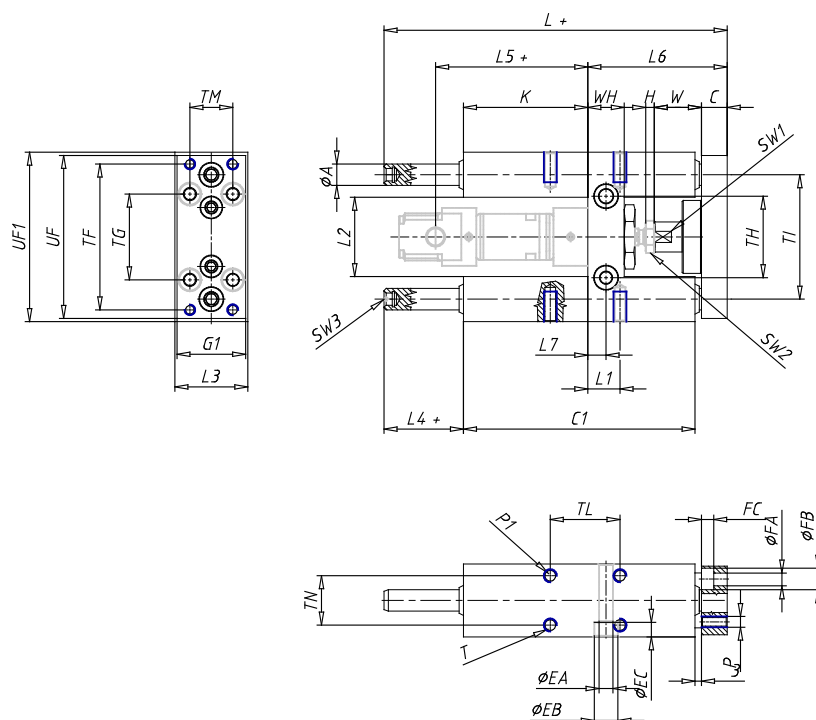

DIMENSIONS

TF (mm)	68
TG (mm)	40.0
TH (mm)	38.0
TI (mm)	58
TM (mm)	20
TL (mm)	32.5
TN (mm)	23
UF1 (mm)	79
UF (mm)	76
G1 (mm)	32
A (mm)	10
WH (mm)	17
C1 (mm)	108
H (mm)	4
W (mm)	22
C (mm)	12
K (mm)	58
L (mm)	160.0
L1 (mm)	15
L2 (mm)	37.0
L3 (mm)	34
L4 (mm)	37
L5 (mm)	71.0

L6 (mm)	65.0
L7 (mm)	8.5
L8 (mm)	0
P	M5
P1	M6
T (mm)	14
EA (mm)	6.5
EB (mm)	11
EC (mm)	6.8
FA (mm)	5.5
FB (mm)	10.0
FC (mm)	5.7
SW1 (mm)	13
SW2 (mm)	13
SW3 (mm)	6