

## Anti-rotation guide units - Series 45

Product code: 45NHT020A0070

Datasheet creation date: 10/03/2025 02:03

Check the most updated document online [click here](#)



### TECHNICAL DATA

<b>Series</b>	45
<b>Diameter (mm)</b>	20
<b>Version</b>	N = standard
<b>Operation</b>	HT = "H" self lubricating guide
<b>Materials</b>	A = anodized aluminium body, stainless steel columns AISI 420B
<b>Stroke (mm)</b>	70

## Anti-rotation guide units - Series 45

Product code: 45NHT020A0070

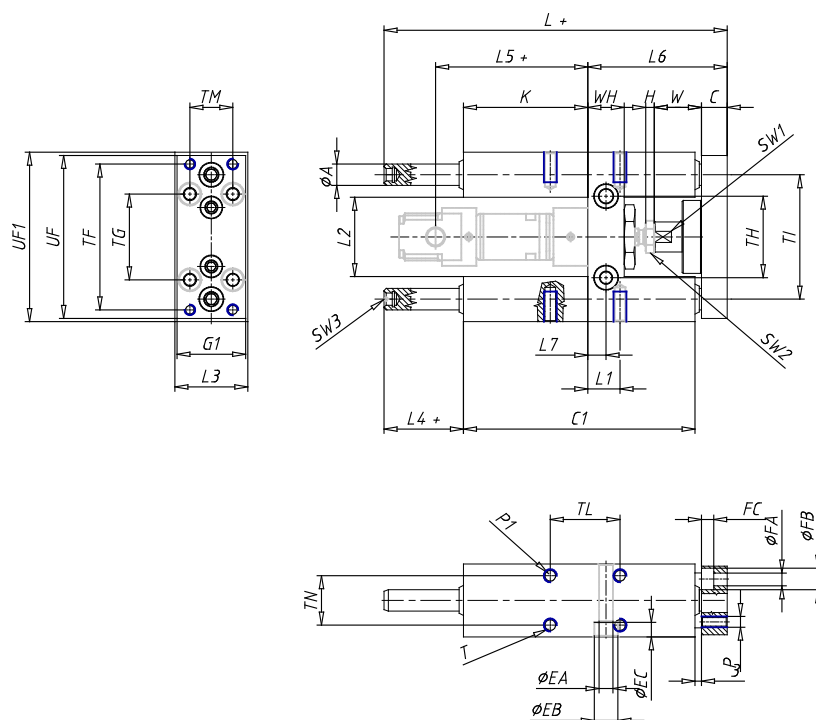

### DIMENSIONS

TF (mm)	68
TG (mm)	40.0
TH (mm)	38.0
TI (mm)	58
TM (mm)	20
TL (mm)	32.5
TN (mm)	23
UF1 (mm)	79
UF (mm)	76
G1 (mm)	32
A (mm)	10
WH (mm)	17
C1 (mm)	108
H (mm)	4
W (mm)	22
C (mm)	12
K (mm)	58
L (mm)	160.0
L1 (mm)	15
L2 (mm)	37.0
L3 (mm)	34
L4 (mm)	37
L5 (mm)	71.0

L6 (mm)	65.0
L7 (mm)	8.5
L8 (mm)	0
P	M5
P1	M6
T (mm)	14
EA (mm)	6.5
EB (mm)	11
EC (mm)	6.8
FA (mm)	5.5
FB (mm)	10.0
FC (mm)	5.7
SW1 (mm)	13
SW2 (mm)	13
SW3 (mm)	6