

Rodless cylinders - Series 50

Product code: 50M2U16A0370

Datasheet creation date: 08/03/2025 11:25

Check the most updated document online [click here](#)



TECHNICAL DATA

Series	50
Version	M = magnetic standard
Operation	2 = double-acting cushioned
Materials	U = anodized AL profile tube, NBR and Polyurethane seals, flange type carriage
Diameter (mm)	16
Construction (mm)	A = standard
Stroke (mm)	370

Rodless cylinders - Series 50

Product code: 50M2U16A0370

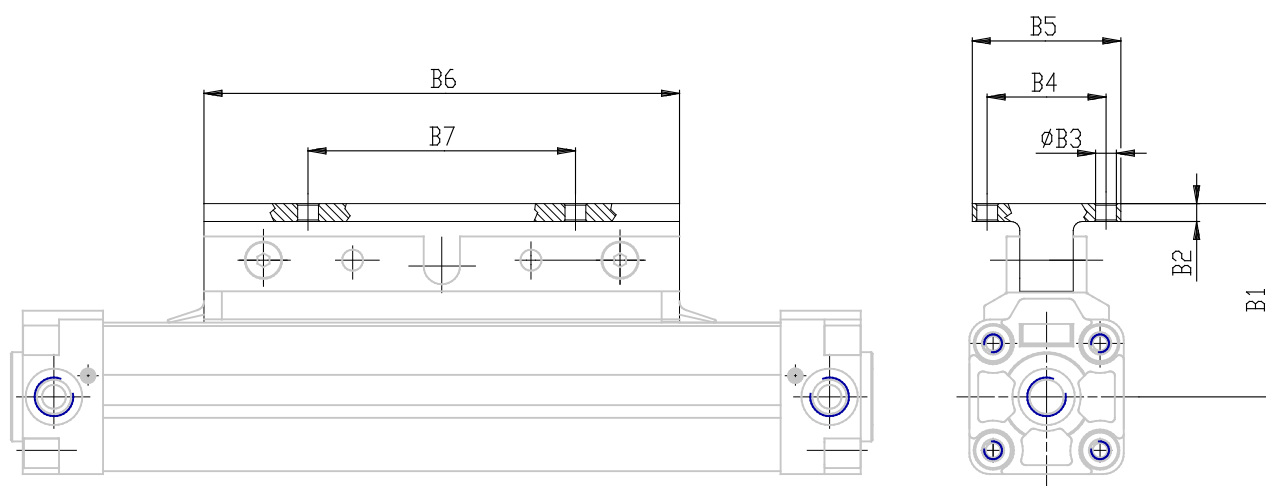

DIMENSIONS

A (mm)	5
B (mm)	32
C (mm)	48
D (mm)	64
E (mm)	76
F	M4
F1 (mm)	8
G (mm)	6
H (mm)	2.0
I (mm)	M5
L (mm)	5.3
L1 (mm)	100
M (mm)	16
N (mm)	15
P (mm)	M3
P1 (mm)	3
Q (mm)	8.0
R (mm)	42.5
S (mm)	28.0
S1 (mm)	27
T (mm)	13.5
U (mm)	10
V (mm)	18

Z (mm)	24
Y (mm)	24.5
W (mm)	27
AA (mm)	29
BB (mm)	30
TG (mm)	18
SW2 (mm)	4
B1 (mm)	36
B2 (mm)	4
B3 (mm)	4.5
B4 (mm)	25
B5 (mm)	40
B6 (mm)	76
B7 (mm)	50