

## Rodless cylinders - Series 50

Product code: 50M2U25A0445

Datasheet creation date: 08/03/2025 11:26

Check the most updated document online [click here](#)



### TECHNICAL DATA

<b>Series</b>	50
<b>Version</b>	M = magnetic standard
<b>Operation</b>	2 = double-acting cushioned
<b>Materials</b>	U = anodized AL profile tube, NBR and Polyurethane seals, flange type carriage
<b>Diameter (mm)</b>	25
<b>Construction (mm)</b>	A = standard
<b>Stroke (mm)</b>	445

## Rodless cylinders - Series 50

Product code: 50M2U25A0445

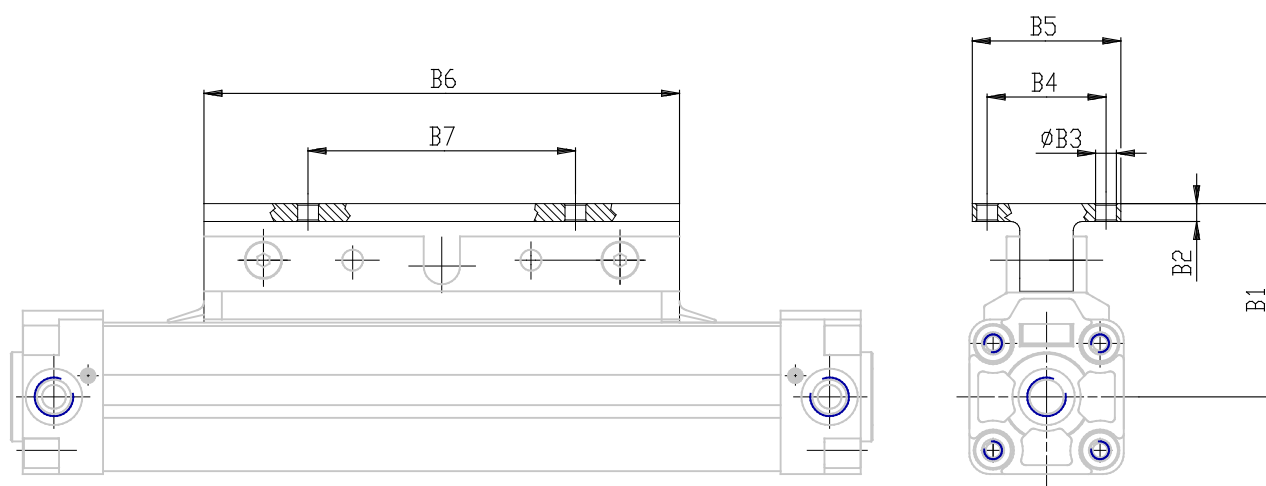

### DIMENSIONS

A (mm)	8
B (mm)	50
C (mm)	80
D (mm)	100
E (mm)	120
F	M5
F1 (mm)	10
G (mm)	13
H (mm)	2.5
I (mm)	G1/8
L (mm)	9.5
L1 (mm)	150
M (mm)	22
N (mm)	25
P (mm)	M5
P1 (mm)	5
Q (mm)	13.5
R (mm)	63.0
S (mm)	40.0
S1 (mm)	40
T (mm)	20.0
U (mm)	15
V (mm)	23

Z (mm)	33
Y (mm)	38.0
W (mm)	40
AA (mm)	43
BB (mm)	46
TG (mm)	27
SW2 (mm)	6
B1 (mm)	51
B2 (mm)	5
B3 (mm)	5.5
B4 (mm)	35
B5 (mm)	50
B6 (mm)	120
B7 (mm)	70