

## Rodless cylinders - Series 50

Product code: 50M2U32A1450

Datasheet creation date: 08/03/2025 11:28

Check the most updated document online [click here](#)



### TECHNICAL DATA

<b>Series</b>	50
<b>Version</b>	M = magnetic standard
<b>Operation</b>	2 = double-acting cushioned
<b>Materials</b>	U = anodized AL profile tube, NBR and Polyurethane seals, flange type carriage
<b>Diameter (mm)</b>	32
<b>Construction (mm)</b>	A = standard
<b>Stroke (mm)</b>	1450

## Rodless cylinders - Series 50

Product code: 50M2U32A1450

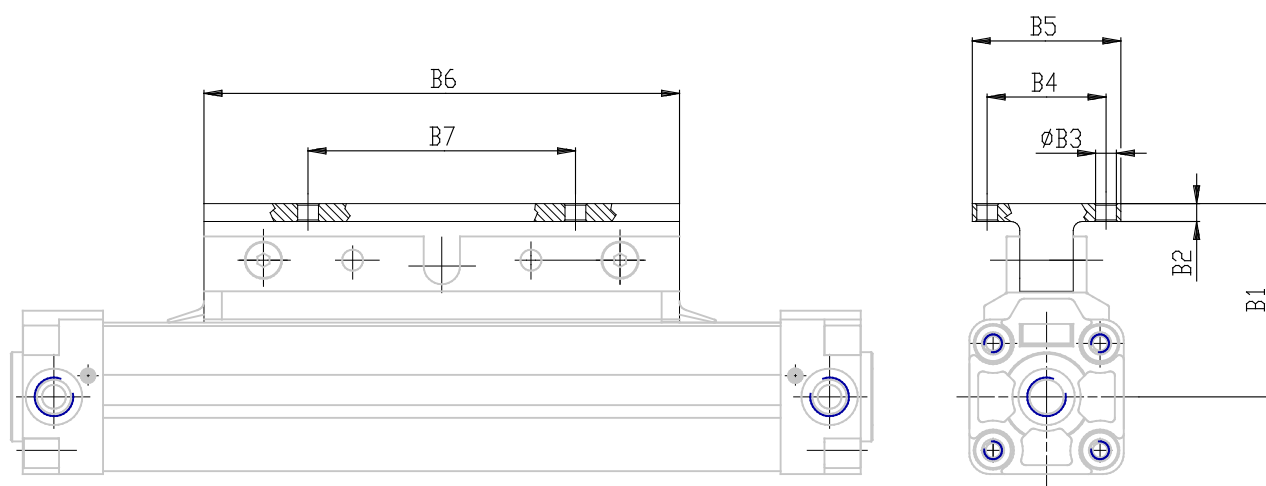

### DIMENSIONS

A (mm)	12
B (mm)	60
C (mm)	90
D (mm)	120
E (mm)	160
F	M6
F1 (mm)	15
G (mm)	14
H (mm)	4.0
I (mm)	G1/4
L (mm)	10.5
L1 (mm)	188
M (mm)	30
N (mm)	31
P (mm)	M6
P1 (mm)	6
Q (mm)	15.0
R (mm)	80.0
S (mm)	52.0
S1 (mm)	52
T (mm)	26.0
U (mm)	18
V (mm)	27

Z (mm)	46
Y (mm)	48.5
W (mm)	45
AA (mm)	54
BB (mm)	60
TG (mm)	36
SW2 (mm)	6
B1 (mm)	66
B2 (mm)	6
B3 (mm)	7.0
B4 (mm)	40
B5 (mm)	50
B6 (mm)	160
B7 (mm)	90