

Rodless cylinders - Series 50

Product code: 50M2U40A0650

Datasheet creation date: 08/03/2025 11:29

Check the most updated document online [click here](#)



TECHNICAL DATA

| | |
|--------------------------|--|
| Series | 50 |
| Version | M = magnetic standard |
| Operation | 2 = double-acting cushioned |
| Materials | U = anodized AL profile tube, NBR and Polyurethane seals, flange type carriage |
| Diameter (mm) | 40 |
| Construction (mm) | A = standard |
| Stroke (mm) | 650 |

Rodless cylinders - Series 50

Product code: 50M2U40A0650

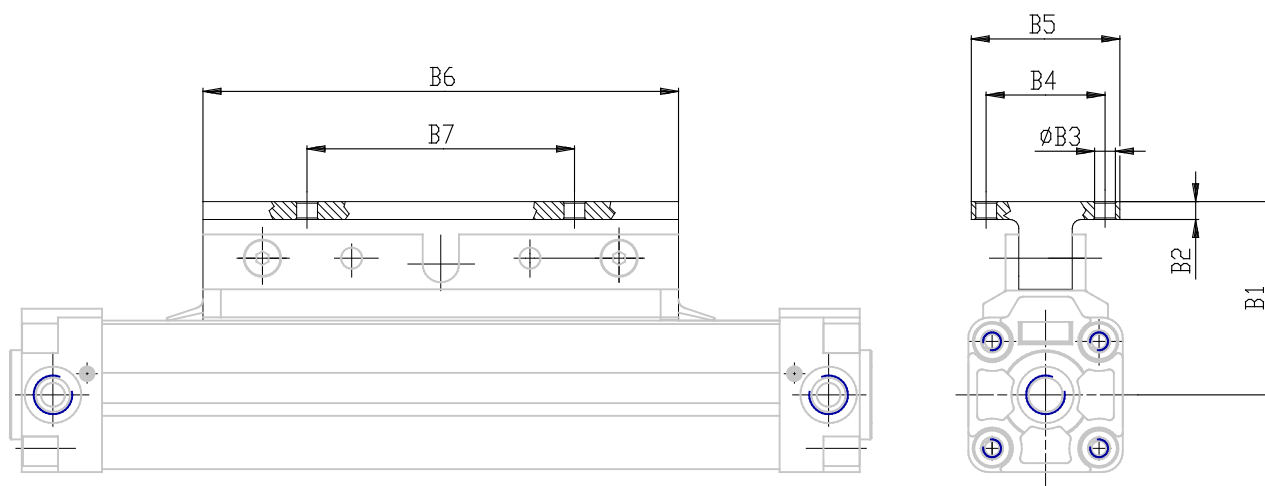

DIMENSIONS

| | |
|---------|------|
| A (mm) | 12 |
| B (mm) | 55 |
| C (mm) | 90 |
| D (mm) | 110 |
| E (mm) | 150 |
| F | M6 |
| F1 (mm) | 12 |
| G (mm) | 12 |
| H (mm) | 4.0 |
| I (mm) | G1/4 |
| L (mm) | 17.5 |
| L1 (mm) | 226 |
| M (mm) | 35 |
| N (mm) | 37 |
| P (mm) | M6 |
| P1 (mm) | 6 |
| Q (mm) | 15.0 |
| R (mm) | 88.5 |
| S (mm) | 63.0 |
| S1 (mm) | 63 |
| T (mm) | 31.5 |
| U (mm) | 18 |
| V (mm) | 28 |

| | |
|----------|------|
| Z (mm) | 49 |
| Y (mm) | 51.0 |
| W (mm) | 75 |
| AA (mm) | 57 |
| BB (mm) | 61 |
| TG (mm) | 43 |
| SW2 (mm) | 6 |
| B1 (mm) | 66 |
| B2 (mm) | 6 |
| B3 (mm) | 7.0 |
| B4 (mm) | 45 |
| B5 (mm) | 60 |
| B6 (mm) | 150 |
| B7 (mm) | 80 |