

Rodless cylinders - Series 50

Product code: 50M2U40A1200

Datasheet creation date: 08/03/2025 11:30

Check the most updated document online [click here](#)



TECHNICAL DATA

Series	50
Version	M = magnetic standard
Operation	2 = double-acting cushioned
Materials	U = anodized AL profile tube, NBR and Polyurethane seals, flange type carriage
Diameter (mm)	40
Construction (mm)	A = standard
Stroke (mm)	1200

Rodless cylinders - Series 50

Product code: 50M2U40A1200

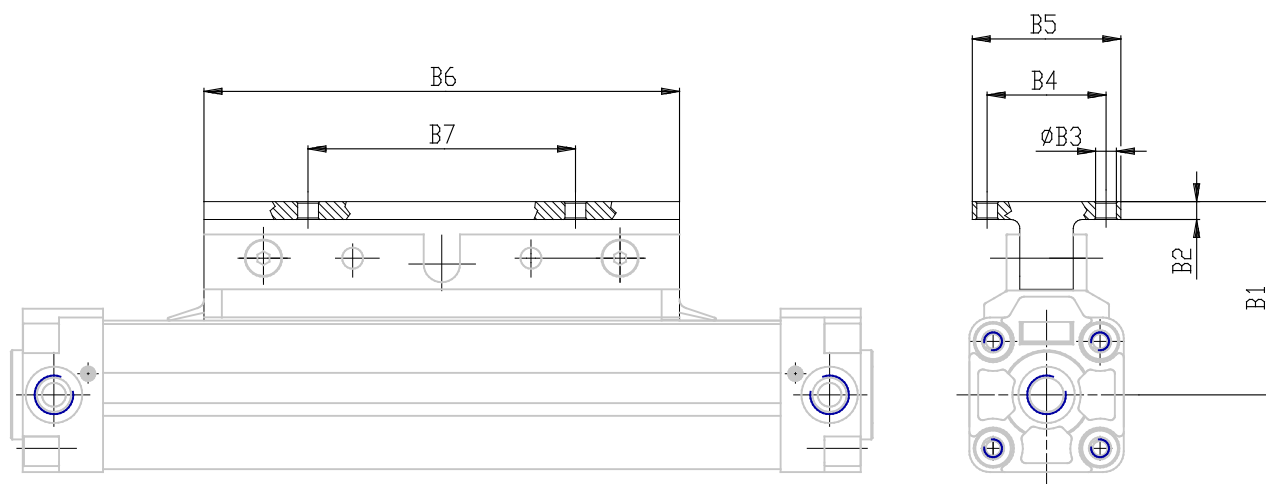

DIMENSIONS

A (mm)	12
B (mm)	55
C (mm)	90
D (mm)	110
E (mm)	150
F	M6
F1 (mm)	12
G (mm)	12
H (mm)	4.0
I (mm)	G1/4
L (mm)	17.5
L1 (mm)	226
M (mm)	35
N (mm)	37
P (mm)	M6
P1 (mm)	6
Q (mm)	15.0
R (mm)	88.5
S (mm)	63.0
S1 (mm)	63
T (mm)	31.5
U (mm)	18
V (mm)	28

Z (mm)	49
Y (mm)	51.0
W (mm)	75
AA (mm)	57
BB (mm)	61
TG (mm)	43
SW2 (mm)	6
B1 (mm)	66
B2 (mm)	6
B3 (mm)	7.0
B4 (mm)	45
B5 (mm)	60
B6 (mm)	150
B7 (mm)	80