

## Rodless cylinders - Series 50

Product code: 50M2U50A0350

Datasheet creation date: 08/03/2025 11:31

Check the most updated document online [click here](#)



### TECHNICAL DATA

<b>Series</b>	50
<b>Version</b>	M = magnetic standard
<b>Operation</b>	2 = double-acting cushioned
<b>Materials</b>	U = anodized AL profile tube, NBR and Polyurethane seals, flange type carriage
<b>Diameter (mm)</b>	50
<b>Construction (mm)</b>	A = standard
<b>Stroke (mm)</b>	350

## Rodless cylinders - Series 50

Product code: 50M2U50A0350

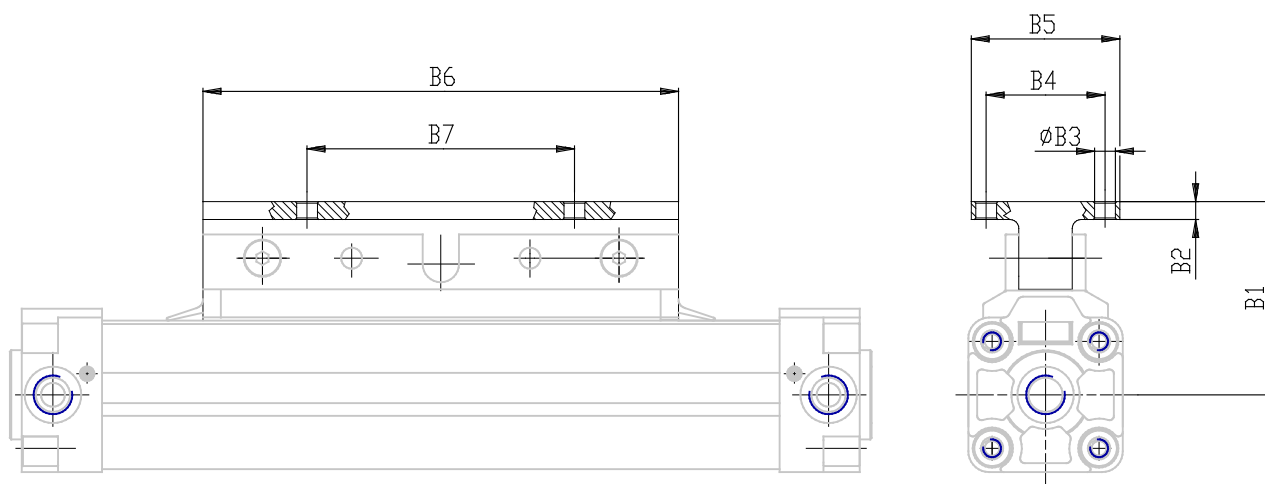

### DIMENSIONS

A (mm)	12
B (mm)	70
C (mm)	110
D (mm)	140
E (mm)	180
F	M6
F1 (mm)	12
G (mm)	12
H (mm)	4.0
I (mm)	G1/4
L (mm)	13.5
L1 (mm)	272
M (mm)	40
N (mm)	39
P (mm)	M8
P1 (mm)	8
Q (mm)	16.0
R (mm)	103.0
S (mm)	74.5
S1 (mm)	76
T (mm)	38.0
U (mm)	18
V (mm)	28

Z (mm)	57
Y (mm)	59.0
W (mm)	85
AA (mm)	65
BB (mm)	69
TG (mm)	53
SW2 (mm)	10
B1 (mm)	74
B2 (mm)	6
B3 (mm)	7.0
B4 (mm)	45
B5 (mm)	60
B6 (mm)	180
B7 (mm)	100