

Rodless cylinders - Series 50

Product code: 50M2U63A0450

Datasheet creation date: 08/03/2025 11:33

Check the most updated document online [click here](#)



TECHNICAL DATA

Series	50
Version	M = magnetic standard
Operation	2 = double-acting cushioned
Materials	U = anodized AL profile tube, NBR and Polyurethane seals, flange type carriage
Diameter (mm)	63
Construction (mm)	A = standard
Stroke (mm)	450

Rodless cylinders - Series 50

Product code: 50M2U63A0450

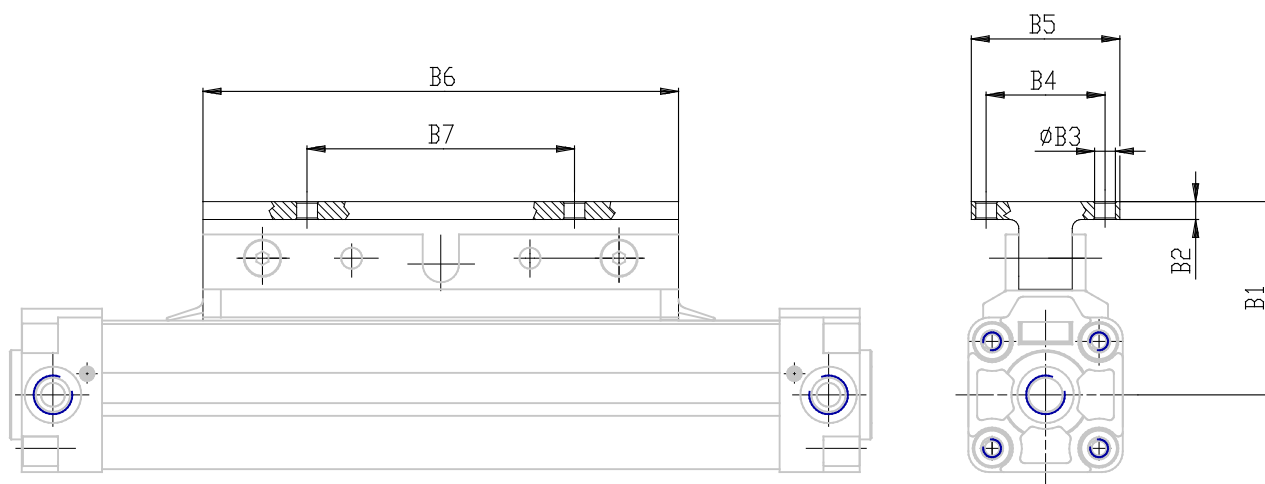

DIMENSIONS

A (mm)	16
B (mm)	90
C (mm)	140
D (mm)	180
E (mm)	220
F	M8
F1 (mm)	15
G (mm)	15
H (mm)	4.0
I (mm)	G3/8
L (mm)	17.5
L1 (mm)	342
M (mm)	45
N (mm)	44
P (mm)	M8
P1 (mm)	8
Q (mm)	16.0
R (mm)	125.0
S (mm)	92.0
S1 (mm)	94
T (mm)	47.0
U (mm)	19
V (mm)	30

Z (mm)	68
Y (mm)	70.0
W (mm)	105
AA (mm)	78
BB (mm)	83
TG (mm)	67
SW2 (mm)	10
B1 (mm)	89
B2 (mm)	7
B3 (mm)	9.0
B4 (mm)	60
B5 (mm)	80
B6 (mm)	220
B7 (mm)	130