

Rodless cylinders - Series 50

Product code: 50M2U80A0250

Datasheet creation date: 08/03/2025 11:34

Check the most updated document online [click here](#)



TECHNICAL DATA

Series	50
Version	M = magnetic standard
Operation	2 = double-acting cushioned
Materials	U = anodized AL profile tube, NBR and Polyurethane seals, flange type carriage
Diameter (mm)	80
Construction (mm)	A = standard
Stroke (mm)	250

Rodless cylinders - Series 50

Product code: 50M2U80A0250

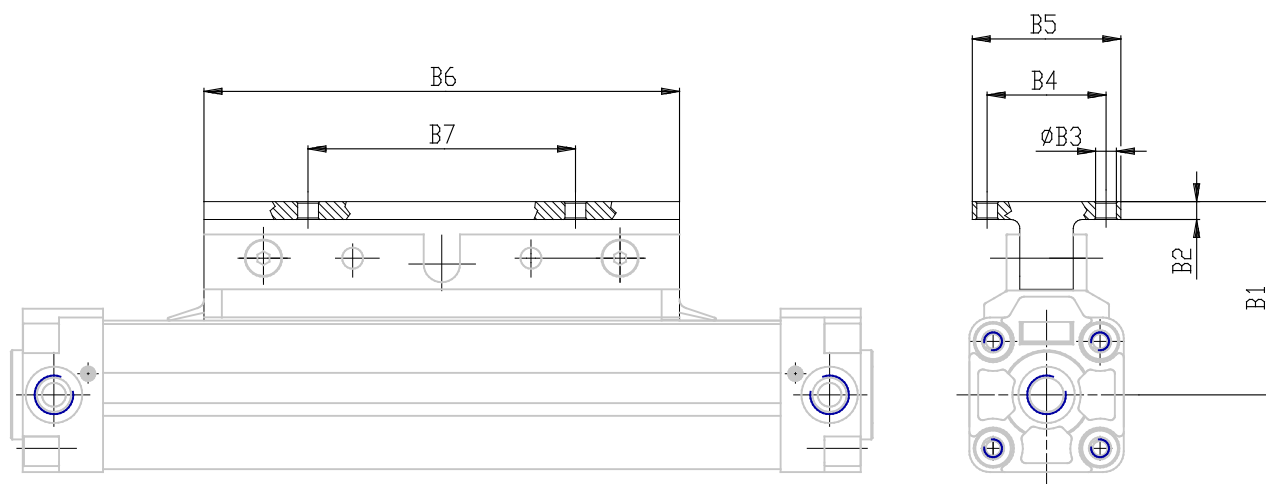

DIMENSIONS

A (mm)	20
B (mm)	120
C (mm)	180
D (mm)	240
E (mm)	280
F	M10
F1 (mm)	20
G (mm)	18
H (mm)	4.0
I (mm)	G1/2
L (mm)	32.0
L1 (mm)	408
M (mm)	45
N (mm)	56
P (mm)	M10
P1 (mm)	10
Q (mm)	18.5
R (mm)	153.5
S (mm)	115.5
S1 (mm)	117
T (mm)	58.5
U (mm)	20
V (mm)	32

Z (mm)	83
Y (mm)	86.0
W (mm)	120
AA (mm)	95
BB (mm)	101
TG (mm)	83
SW2 (mm)	12
B1 (mm)	108
B2 (mm)	8
B3 (mm)	11.0
B4 (mm)	75
B5 (mm)	100
B6 (mm)	280
B7 (mm)	180