

Rodless cylinders - Series 52

Product code: 52M8C50A0350

Datasheet creation date: 08/03/2025 13:26

Check the most updated document online [click here](#)



TECHNICAL DATA

Series	52M8C50A
Diameter (mm)	50
Version	M= standard
Operation	8 = double-acting, cushioned, with air supply from one side only
Materials	C = anodized AL profile, NBR and Polyurethane seals, short carriage
Construction	A = standard
Stroke Cylinder (mm)	350

Rodless cylinders - Series 52

Product code: 52M8C50A0350

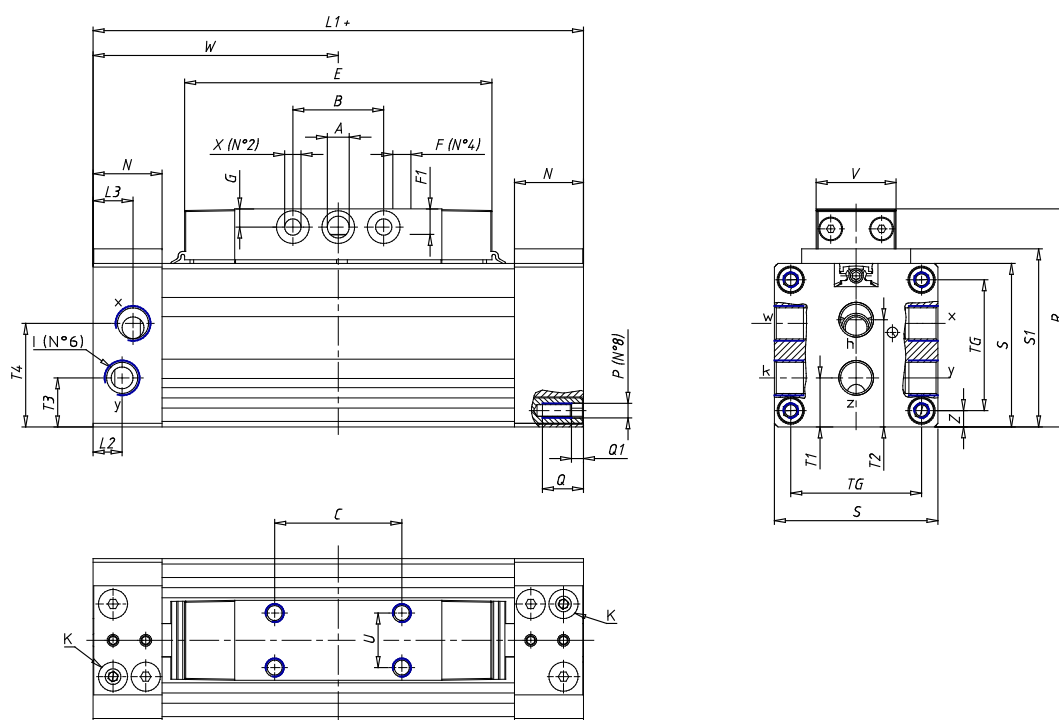

DIMENSIONS

W (mm)	105.0
E (mm)	122.0
L1 (mm)	210
I	G3/8
B (mm)	35
G (mm)	9.0
N (mm)	30
L (mm)	17.0
Ø A (mm)	10.0
Ø X (mm)	8.5
S1 (mm)	94
T (mm)	59.0
Z (mm)	12.5
C1 (mm)	0
C (mm)	64
U (mm)	34
F	M8
F1 (mm)	16.0
H (mm)	0.0
V (mm)	46.0
S (mm)	90
R (mm)	115
P	M8

TG (mm)	65
Q (mm)	17
Q1 (mm)	5
T1 (mm)	29.5
T2 (mm)	59.0
T3 (mm)	29.0
T4 (mm)	59.0
L2 (mm)	17.0
L3 (mm)	17.0
D (mm)	10.5
M (mm)	4.5
J	0
JP (mm)	0.0
J1 (mm)	0
R1 (mm)	133.0
X1 (mm)	3.0
Y (mm)	4.5
Y1 (mm)	3.0
Y2 (mm)	0
Y3 (mm)	6
R2 (mm)	0.0