

## Rodless cylinders - Series 52

Product code: 52M8C63A2000

Datasheet creation date: 08/03/2025 13:30

Check the most updated document online [click here](#)



### TECHNICAL DATA

<b>Series</b>	52M8C63A
<b>Diameter (mm)</b>	63
<b>Version</b>	M= standard
<b>Operation</b>	8 = double-acting, cushioned, with air supply from one side only
<b>Materials</b>	C = anodized AL profile, NBR and Polyurethane seals, short carriage
<b>Construction</b>	A = standard
<b>Stroke Cylinder (mm)</b>	2000

## Rodless cylinders - Series 52

Product code: 52M8C63A2000

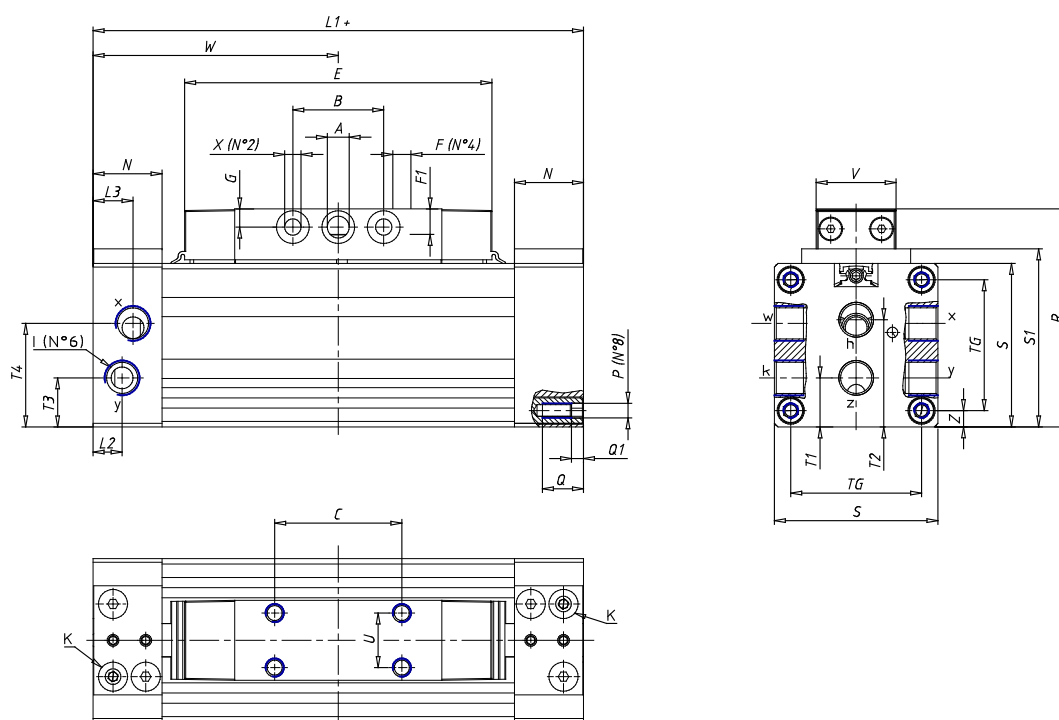

### DIMENSIONS

W (mm)	125.0
E (mm)	150.0
L1 (mm)	250
I	G3/8
B (mm)	50
G (mm)	9.5
N (mm)	30
L (mm)	17.0
Ø A (mm)	10.0
Ø X (mm)	8.5
S1 (mm)	110
T (mm)	68.5
Z (mm)	14.0
C1 (mm)	0
C (mm)	80
U (mm)	34
F	M8
F1 (mm)	16.0
H (mm)	0.0
V (mm)	46.0
S (mm)	106
R (mm)	131
P	M8

TG (mm)	78
Q (mm)	17
Q1 (mm)	5
T1 (mm)	34.0
T2 (mm)	68.5
T3 (mm)	34.0
T4 (mm)	68.5
L2 (mm)	17.0
L3 (mm)	17.0
D (mm)	10.5
M (mm)	4.5
J	0
JP (mm)	0.0
J1 (mm)	0
R1 (mm)	150.0
X1 (mm)	6.5
Y (mm)	4.5
Y1 (mm)	6.5
Y2 (mm)	0
Y3 (mm)	6
R2 (mm)	0.0