

Rodless cylinders - Series 52

Product code: 52R8C25A0300

Datasheet creation date: 08/03/2025 12:22

Check the most updated document online [click here](#)



TECHNICAL DATA

Series	52R8C25A
Diameter (mm)	25
Version	R = with roller bearing
Operation	8 = double-acting, cushioned, with air supply from one side only
Materials	C = anodized AL profile, NBR and Polyurethane seals, short carriage
Construction	A = standard
Stroke Cylinder (mm)	300

Rodless cylinders - Series 52

Product code: 52R8C25A0300

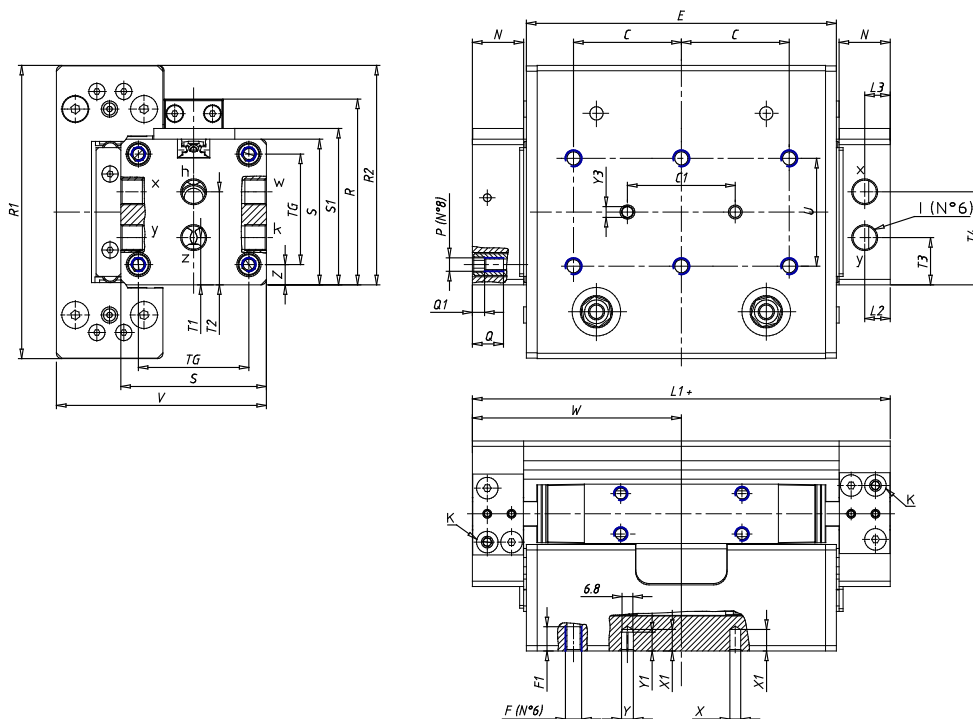

DIMENSIONS

W (mm)	67.5
E (mm)	95.0
L1 (mm)	135
I	G1/8
B (mm)	0
G (mm)	6.5
N (mm)	19
L (mm)	9.5
Ø A (mm)	0.0
Ø X (mm)	4.0
S1 (mm)	49
T (mm)	25.0
Z (mm)	4.5
C1 (mm)	40
C (mm)	20
U (mm)	40
F	M5
F1 (mm)	7.5
H (mm)	0.0
V (mm)	68.2
S (mm)	45
R (mm)	60
P	M4

TG (mm)	36
Q (mm)	11
Q1 (mm)	3
T1 (mm)	13.5
T2 (mm)	29.5
T3 (mm)	13.5
T4 (mm)	28.5
L2 (mm)	8.0
L3 (mm)	11.0
D (mm)	10.5
M (mm)	4.5
J	-
JP (mm)	0.0
J1 (mm)	0
R1 (mm)	75.0
X1 (mm)	5.5
Y (mm)	4.5
Y1 (mm)	4.5
Y2 (mm)	4
Y3 (mm)	4
R2 (mm)	71.0