

## Rodless cylinders - Series 52

Product code: 52R8C32A0150

Datasheet creation date: 08/03/2025 12:28

Check the most updated document online [click here](#)



### TECHNICAL DATA

<b>Series</b>	52R8C32A
<b>Diameter (mm)</b>	32
<b>Version</b>	R = with roller bearing
<b>Operation</b>	8 = double-acting, cushioned, with air supply from one side only
<b>Materials</b>	C = anodized AL profile, NBR and Polyurethane seals, short carriage
<b>Construction</b>	A = standard
<b>Stroke Cylinder (mm)</b>	150

## Rodless cylinders - Series 52

Product code: 52R8C32A0150

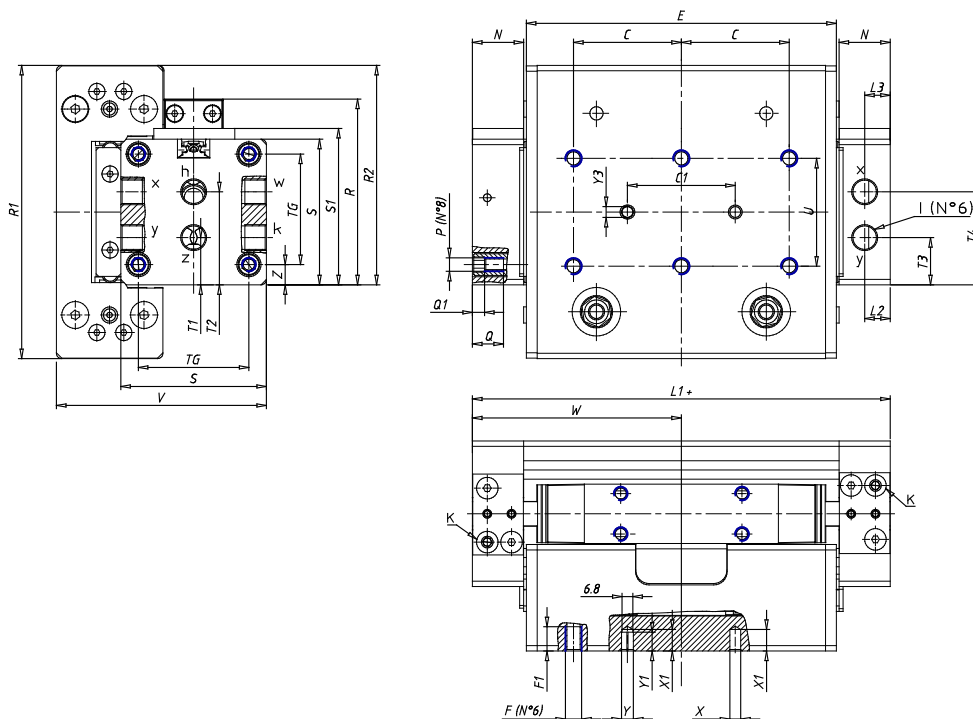

### DIMENSIONS

W (mm)	77.5
E (mm)	115.0
L1 (mm)	155
I	G1/8
B (mm)	0
G (mm)	6.5
N (mm)	19
L (mm)	9.5
Ø A (mm)	0.0
Ø X (mm)	4.0
S1 (mm)	58
T (mm)	32.5
Z (mm)	7.5
C1 (mm)	40
C (mm)	40
U (mm)	40
F	M5
F1 (mm)	9.0
H (mm)	0.0
V (mm)	78.0
S (mm)	54
R (mm)	69
P	M5

TG (mm)	41
Q (mm)	11
Q1 (mm)	4
T1 (mm)	17.5
T2 (mm)	34.5
T3 (mm)	17.5
T4 (mm)	34.5
L2 (mm)	9.5
L3 (mm)	9.5
D (mm)	10.5
M (mm)	4.5
J	M5
JP (mm)	0.8
J1 (mm)	9
R1 (mm)	83.8
X1 (mm)	8.0
Y (mm)	4.5
Y1 (mm)	7.0
Y2 (mm)	4
Y3 (mm)	4
R2 (mm)	81.4