

Rodless cylinders - Series 52

Product code: 52R8C40A0250

Datasheet creation date: 08/03/2025 12:36

Check the most updated document online [click here](#)



TECHNICAL DATA

| | |
|-----------------------------|---|
| Series | 52R8C40A |
| Diameter (mm) | 40 |
| Version | R = with roller bearing |
| Operation | 8 = double-acting, cushioned, with air supply from one side only |
| Materials | C = anodized AL profile, NBR and Polyurethane seals, short carriage |
| Construction | A = standard |
| Stroke Cylinder (mm) | 250 |

Rodless cylinders - Series 52

Product code: 52R8C40A0250

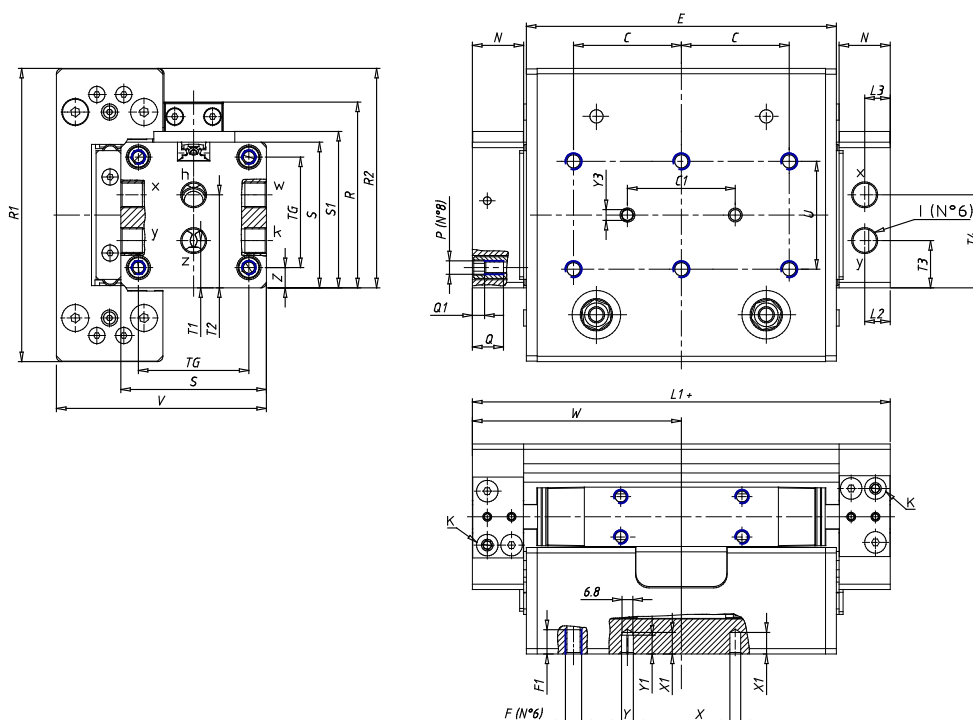

DIMENSIONS

| | |
|----------|-------|
| W (mm) | 95.0 |
| E (mm) | 143.5 |
| L1 (mm) | 190 |
| I | G1/4 |
| B (mm) | 0 |
| G (mm) | 6.5 |
| N (mm) | 23 |
| L (mm) | 11.5 |
| Ø A (mm) | 0.0 |
| Ø X (mm) | 6.0 |
| S1 (mm) | 68 |
| T (mm) | 38.0 |
| Z (mm) | 7.5 |
| C1 (mm) | 40 |
| C (mm) | 55 |
| U (mm) | 55 |
| F | M5 |
| F1 (mm) | 12.0 |
| H (mm) | 0.0 |
| V (mm) | 90.5 |
| S (mm) | 64 |
| R (mm) | 82 |
| P | M6 |

| | |
|---------|-------|
| TG (mm) | 49 |
| Q (mm) | 12 |
| Q1 (mm) | 4 |
| T1 (mm) | 15.5 |
| T2 (mm) | 38.0 |
| T3 (mm) | 20.5 |
| T4 (mm) | 42.5 |
| L2 (mm) | 11.5 |
| L3 (mm) | 11.5 |
| D (mm) | 10.5 |
| M (mm) | 4.5 |
| J | - |
| JP (mm) | 0.0 |
| J1 (mm) | 0 |
| R1 (mm) | 100.0 |
| X1 (mm) | 8.0 |
| Y (mm) | 6.5 |
| Y1 (mm) | 7.0 |
| Y2 (mm) | 6 |
| Y3 (mm) | 6 |
| R2 (mm) | 104.5 |